



ALLERGARD™ ES ENERGY SAVER CONTAINMENT SMALL ANIMAL TRANSFER STATION

NU-620/621

OPERATIONS & MAINTENANCE MANUAL



OM0307

Revision 3

January 2024



Manufactured By:

NuAire, Inc.

2100 Fernbrook Lane

Plymouth, MN 55447

Toll-Free: 1-800-328-3352

In Minnesota: (763)-553-1270

Fax: (763)-553-0459

About this Operation and Maintenance Manual

The information contained in this manual is intended to reflect our current production model along with the more frequently purchased options. Any unique additions, modifications, or shop drawings are appended in the back flap of this manual, along with any modifications and/or additions to procedures as outlined in this manual. A copy of the original factory test report is also appended to this manual. In case this manual and/or test report is lost or misplaced, NuAire retains a copy in our files. A replacement copy can be obtained by calling or writing NuAire, Inc. stating the model number and serial number and a brief description of the information desired.

TABLE OF CONTENTS

1.0	General Description	5
1.1	Safety Instructions	6
1.2	Explanation of Symbols	6
2.0	Models & Features	7
3.0	Warranty	11
4.0	Shipments	11
4.1	Damaged Shipments	11
5.0	Installation Instructions	12
5.1	Location	12
5.2	Set-Up Instructions	12
5.3	Plumbing Services	12
5.4	Electrical Services	13
5.5	Certification	13
6.0	Operating the NU-620	15
6.1	Aeromax™ Control System	15
7.0	Operating Guidelines	21
7.1	Operating Sequence:	21
7.2	Ergonomics	22
7.3	Cleaning Procedures	22
8.0	General Maintenance	23
8.1	Preventative Maintenance	23
8.2	LED Lamp Replacement	24
8.3	HEPA Filter Replacement	24
8.4	Motor/Blower Replacement	25
8.5	Airflow Control System Setup and Calibration	25
8.6	Airflow Calibration	25
8.7	Filter Integrity Check	28
8.8	PresurFlow™ Alarm Set Points	29
8.9	Decontamination	30
9.0	Polycarbonate Material Compatibility	31
10.0	Error Indicators, Troubleshooting & Option Parameters	32
10.1	Error indicators occur for a variety of reasons.	32
10.2	Option Parameters	33
11.0	Remote Contacts	35
11.1	Fan Relay	35
11.2	Alarm Relay	35
11.3	15VDC Output	35
12.0	Electrical/Environmental Requirements	36
12.1	Electrical: (Supply voltage fluctuations not to exceed +/-10%)	36
12.2	Operational Performance - Indoor Use Only	36
12.3	Light Exposure	36
12.4	Installation Category: II	36
12.5	Pollution Degree: 2.0	36
12.6	Chemical Exposure	36
12.7	EMC Performance (classified for light industrial)	36
13.0	Disposal and Recycle	37
14.0	Preventive Maintenance Checklist	38

Manual Drawings

CD-00174.....NU-620/621-300 Specification Drawing
CD-00175.....NU-620/621-400 Specification Drawing
CD-00176.....NU-620/621-500 Specification Drawing
BCD-16521Front Panel

Electrical Schematic

CD-000082.....NU-620/621-300/400/500 ELSH

**AllerGard™ ES Energy Saver Containment
Small Animal Transfer Station
Models
NU-620-300/400/500
NU-621-300/400/500
Manufactured By:
NuAire, Inc. - Plymouth, Minnesota, USA**

1.0 General Description

The NuAire AllerGard™ ES Energy Saver Containment Small Animal Transfer Station Model NU-620 is a station whose unique configuration offers the benefits of vertical HEPA filtered airflow for product protection on the worksurface. In addition, the NU-620 provides improved allergen personnel protection by incorporating a HEPA filtered down draft vacuum on the worksurface to assure minimal exposure to animal hair/dander as well as cage bedding material. **However, the NuAire Model NU-620 should not be used as a substitute for a Class II, Type A2 Biosafety Cabinet (BSC). The NU-620 is not a containment device for airborne particulate in low to moderate risk-hazard research** as prescribed by the CDC/NIH Biosafety in Microbiological and Biomedical Laboratories.

The NU-620 design and basic airflow pattern is illustrated on the specification drawing. The NU-620 design incorporates two impeller/blowers, both a supply and exhaust, each with its own associated HEPA filter providing excellent system function and maximum filter loading capacity. The designed airflow pattern, being a single pass system, also eliminates any heat buildup within the work zone. The airflow pattern starts with the supply prefilter located on top of the station. The airflow continues through the supply impeller/blower and forced into the supply HEPA filter providing 99.99% particle removal at 0.3 micron. The airflow continues to move in a uniform vertical downflow pattern providing particulate-free air in the work zone.

NuAire offers two window configurations being either dual access or single access. The dual access design along with the work surface configuration allows the greatest access while maintaining work zone sterility and improved allergen protection. The single access design meets BSC containment performance levels for personnel and protection.







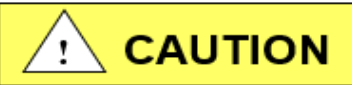

The downdraft HEPA filter provides 99.99% particle removal at 0.3 micron and is located under the worktray in its own impeller/blower/filter cabinet. As the air is pulled from the worktray, through the prefilter and into the blower, the air then passes through the downdraft HEPA filter and is exhausted back to the room providing improved allergen personnel and environmental protection.

1.1 Safety Instructions

These safety instructions describe the safety features of the AllerGard™ ES Energy Saver Small Animal Transfer Station Model NU-620. The station has been manufactured using the latest technological developments and has been thoroughly tested before delivery. **However, the station may present potential hazards if it is not installed and used as instructed for its intended purpose or outside of operating parameters.** Therefore, the following procedures must always be observed:

- The station must be operated only by trained and authorized personnel.
- For any operation of this unit, the operator must prepare clear and concise written instructions for operating and cleaning, utilizing applicable safety data sheets, plant hygiene guidelines, and technical regulations, in particular.
 - Which decontamination measures are to be applied for the station and accessories?
 - Which protective measures apply while specific agents are used?
 - Which measures are to be taken in the case of an accident?
- Repairs to the device must be carried out only by trained and authorized expert personnel.
- Keep these operating instructions close to the station so that safety instructions and important information are always accessible.
- Should you encounter problems that are not detailed adequately in the operating instructions, please contact your NuAire Representative of NuAire technical Services.

1.2 Explanation of Symbols

Symbol	Explanation
	Safety alert symbol indicate a potentially hazardous situation which, if not avoided, could result in death or serious injury.
	Safety alert symbol indicates a potentially hazardous situation which, if not avoided, may result in minor or moderate injury.
	CAUTION used without the safety alert symbol indicates a potentially hazardous situation which, if not avoided, may result in property damage.
	Potential electrical hazard, only qualified person to access
	Biohazard
	Ground, Earth
	Lead Free
	Flammable Hazard
	Hazardous Gasses! Personal Protection Equipment Required.
	Chemical Hazard

2.0 Models & Features

The Model NU-620 AllerGard™ ES Energy Saver Containment Small Animal Transfer Station is manufactured in 3 sizes:

Dual Sided		Single Sided	
620-300	3 ft. (.91m)	621-300	3 ft. (.91m)
620-400	4 ft. (1.2m)	621-400	4 ft. (1.2m)
620-500	5 ft. (1.5m)	621-500	5 ft. (1.5m)

REV	CO	DESCRIPTION	DATE	DFTR	CHKD
A	002417	RELEASED TO PRODUCTION	09/12/2023	RN	DF

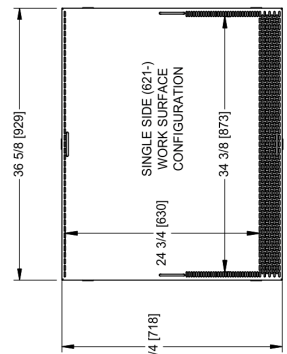
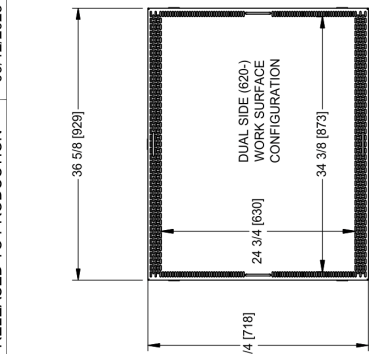

NOTE: THIS CABINET CONTAINS ELECTRONIC COMPONENTS THAT MAY CAUSE SOME GROUND FAULT CIRCUIT INTERRUPTER (GFCI) DEVICES TO INADVERTENTLY TRIP DUE TO INHERENT DESIGN DIFFERENCES. USE AT YOUR OWN RISK.

TITLE				NU-620/621-300 SPECIFICATION DRAWING	
DFTR	RN	DATE	CHKD	DF	SHEET 1 OF 1
					CD-000174
DRAWING NUMBER					A

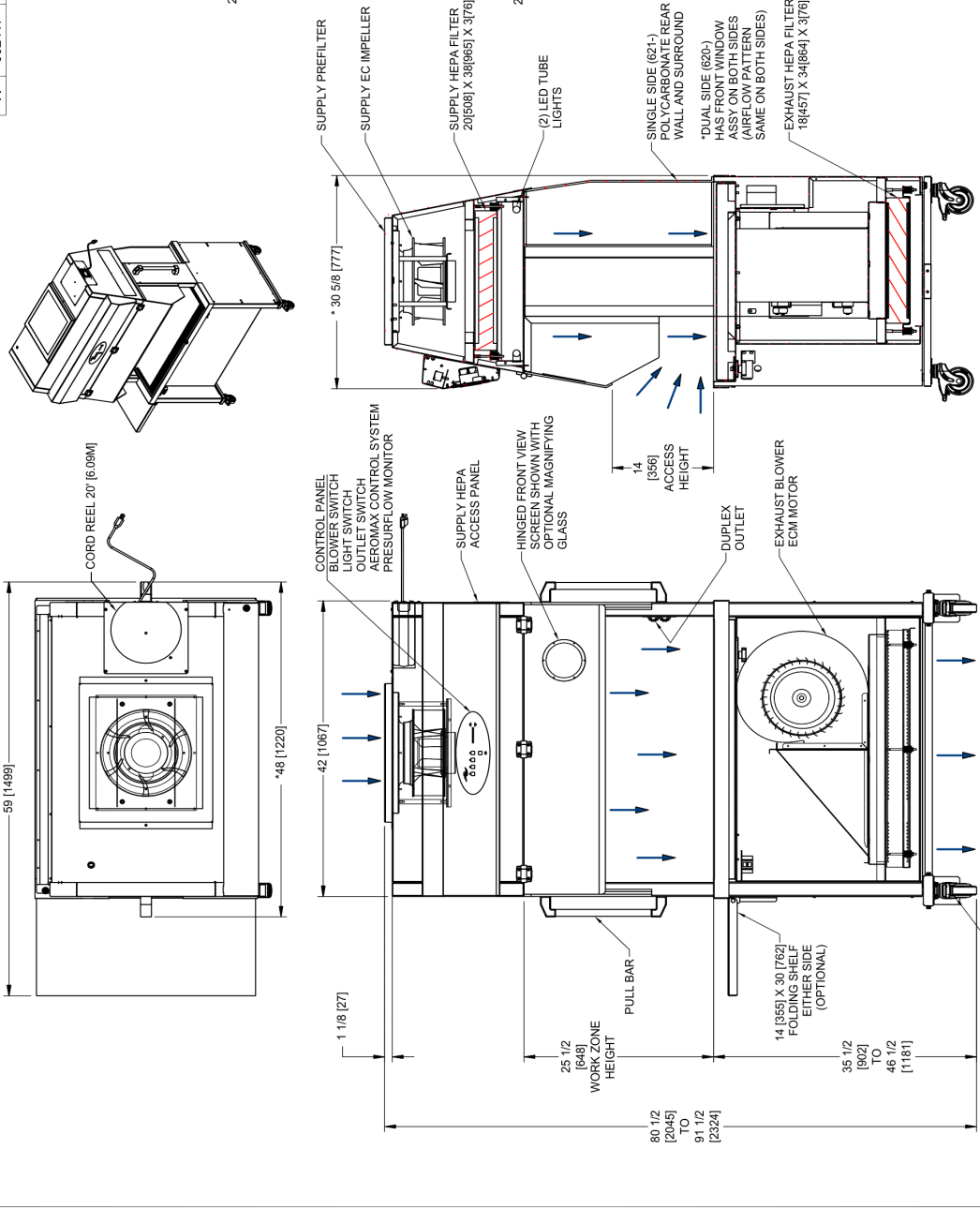

* OVERALL DIMENSIONAL TOLERANCE ±1/4 [6.35]
ALL OTHER DIMENSIONS ±1/8 [3.17]



REV	CO	DESCRIPTION	DATE	DFTR	CHKD
A	002417	RELEASED TO PRODUCTION	09/12/2023	RN	DF

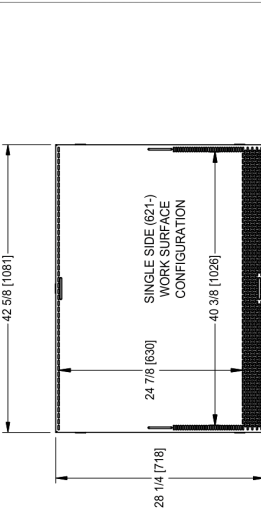
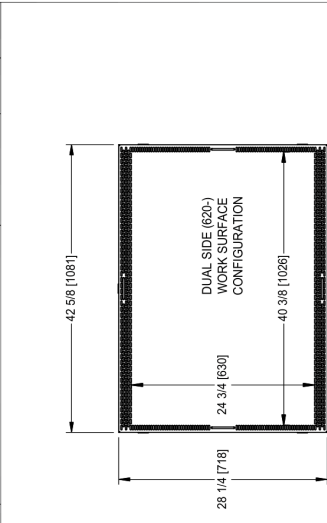

NOTE: THIS CABINET CONTAINS ELECTRONIC COMPONENTS THAT MAY CAUSE SOME GROUND FAULT CIRCUIT INTERRUPTER (GFCI) DEVICES TO INADVERTENTLY TRIP DUE TO INHERENT DESIGN DIFFERENCES. USE AT YOUR OWN RISK.

* OVERALL DIMENSIONAL TOLERANCE ±1/4 [6.35] ALL OTHER DIMENSIONS ±1/8 [3.17]

TITLE		NU-620/621-400 SPECIFICATION DRAWING	
DFTR	RN	DATE	8/29/2023
CHKD	DF	SHEET	1 OF 1
DRAWING NUMBER	CD-000175		
		A	

REV	CO	DESCRIPTION	DATE	DFTR	CHKD
A	002417	RELEASED TO PRODUCTION	09/12/2023	RN	DF

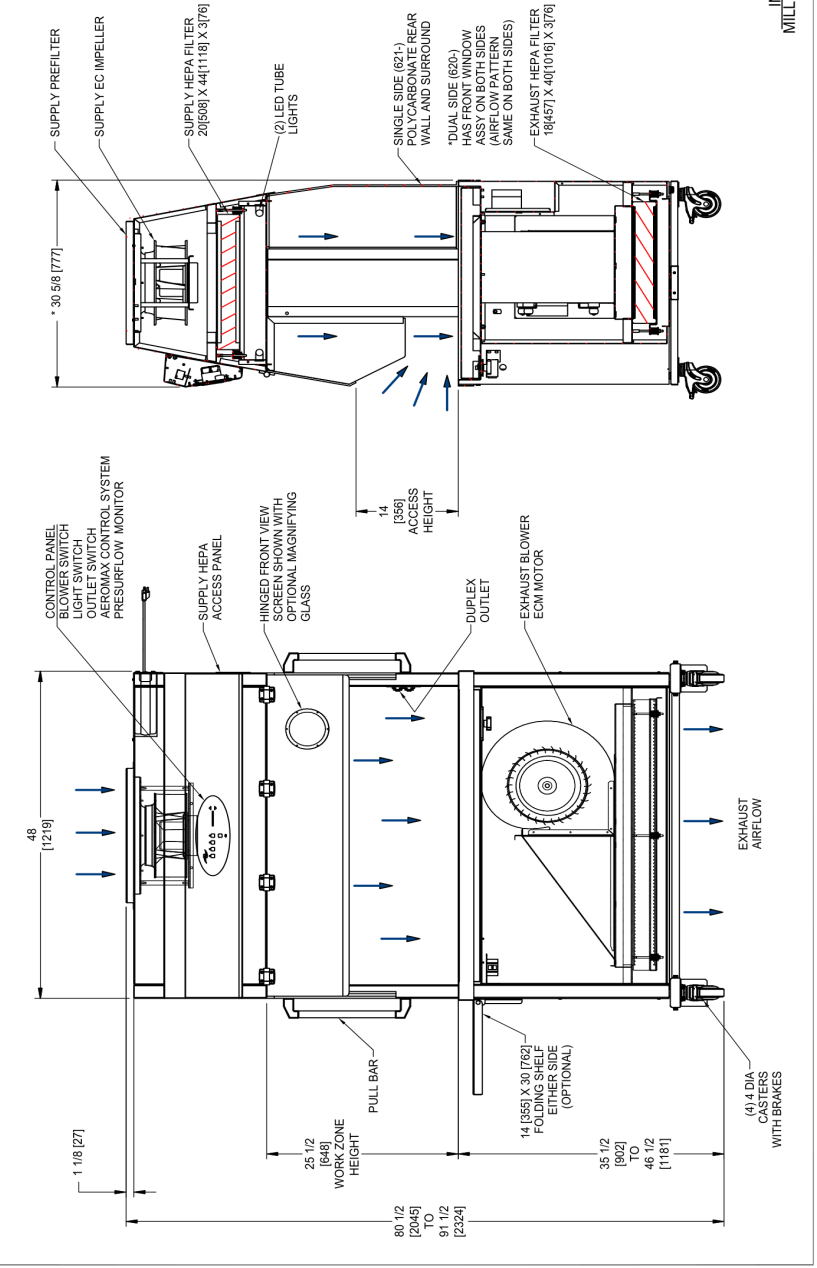
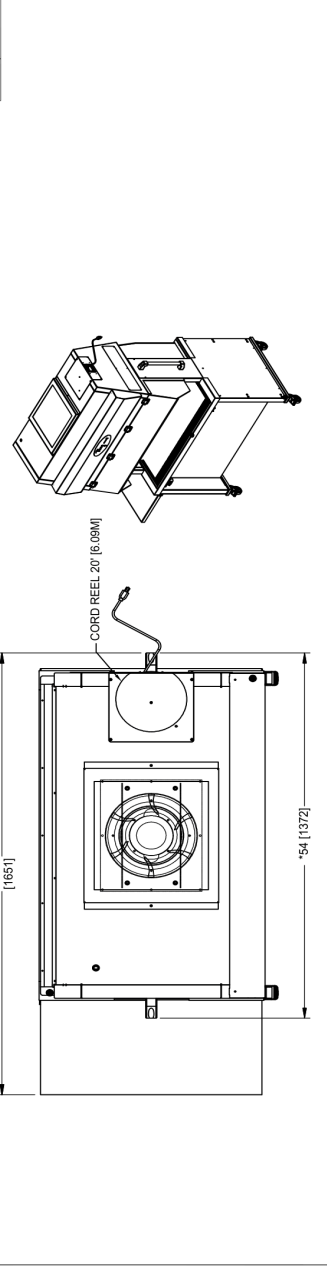

INCH
MILLIMETER

REV	CO	DESCRIPTION	DATE	DFTR	CHKD
A	002417	RELEASED TO PRODUCTION	09/12/2023	RN	DF

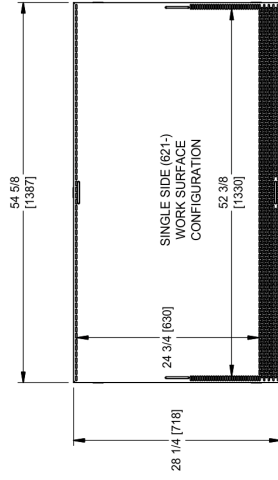
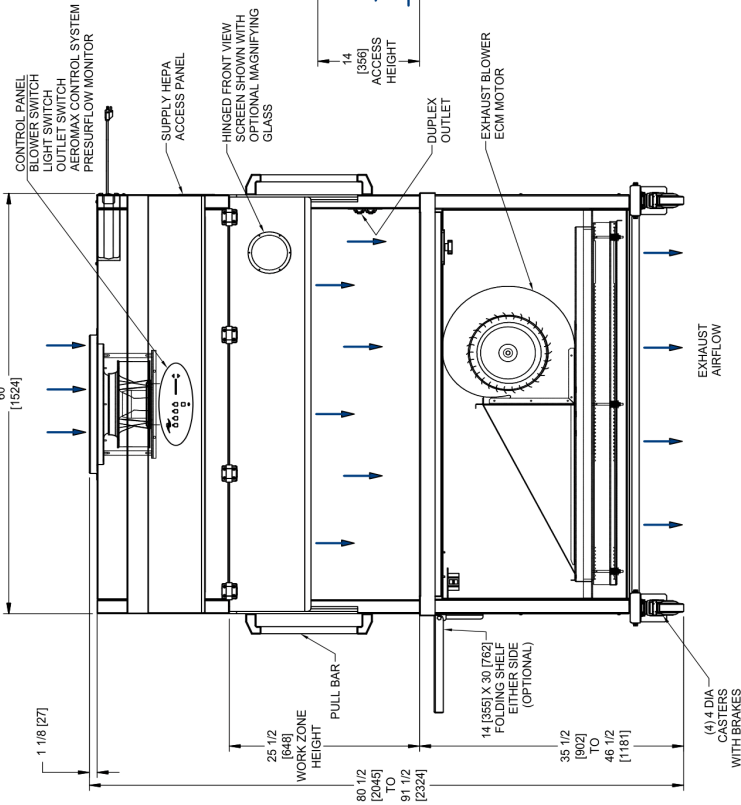
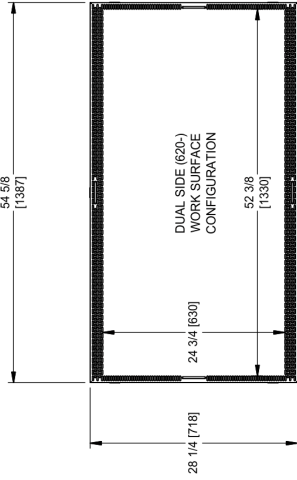
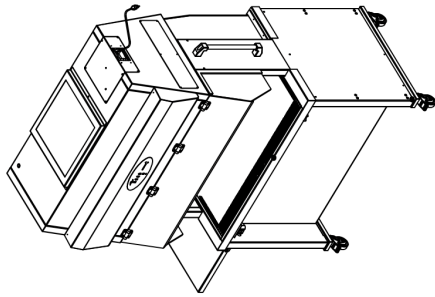
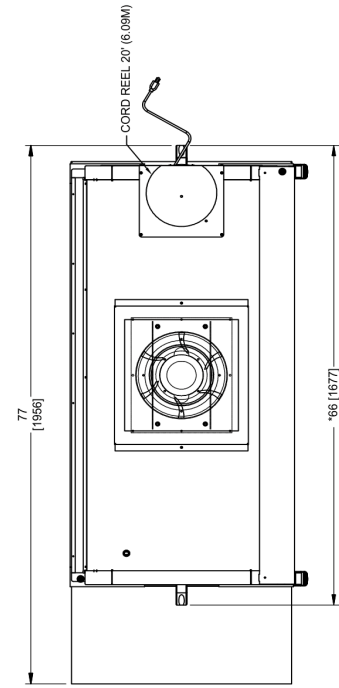

NOTE: THIS CABINET CONTAINS ELECTRONIC COMPONENTS THAT MAY CAUSE SOME GROUND FAULT CIRCUIT INTERRUPTER (GFCI) DEVICES TO INADVERTENTLY TRIP DUE TO INHERENT DESIGN DIFFERENCES. USE AT YOUR OWN RISK.

* OVERALL DIMENSIONAL TOLERANCE ±1/4 [6.35] ALL OTHER DIMENSIONS ±1/16 [3.17]



TITLE

NIJ-620/621-500 SPECIFICATION DRAWING

DFTR	RN	DATE	CHKD	DF	SHEET	OF
					1	1

INCH
MILLIMETER

CD-000176

A

3.0 Warranty

Details regarding product warranties can be found in the published warranty data separate from this manual and included within the data packet sent with the unit.

4.0 Shipments

NuAire takes every reasonable precaution to ensure that your ALLERGARD™ ES ENERGY SAVER CONTAINMENT SMALL ANIMAL TRANSFER STATION arrives without damage. Motor carriers are carefully selected and shipping cartons have been specially designed to protect your purchase. However, damage can occur in any shipment and the following outlines the steps you should take on receipt to be sure that if damage has occurred, the proper claims and actions are taken immediately.

4.1 Damaged Shipments

- 4.1.1** Terms are factory, unless stated otherwise. Therefore, it is important to check each shipment before acceptance.
- 4.1.2** If there is visible damage, the material can be accepted after the driver makes a notation on the consignee's copy of the freight bill. Then an inspection must be made to verify the claim against the carrier. This inspection is the basis of your filing the claim against the carrier.
- 4.1.3** If concealed damage is found, it is absolutely necessary to NOTIFY THE FREIGHT AGENT AT ONCE and request an inspection. Without this inspection, the transportation company may not accept a claim for loss or damage. If the carrier will not perform the inspection, an affidavit must be prepared stating that he was contacted on a certain date and that he failed to comply with the request. This along with other papers in the customer's possession will support the claim.

5.0 Installation Instructions

5.1 Location

The NU-620 Station can be located anywhere within the animal facility. However, for maximum product protection, the station should be used away from laboratory personnel traffic lanes, air vents (in or out), doors, and/or any other source of disruptive air currents.

If drafts or other disruptive air currents exceed the downflow velocity of the station through the access opening, the potential exists for contaminated room air to enter the work zone. Remember: Always use proper laboratory techniques.

5.2 Set-Up Instructions

Remove outer shipping protection (carton or crating). The station is fastened to the base skid and it is usually the best procedure to leave the skid in place until the station is located in its approximate position to facilitate ease in handling. It can be disconnected from the skid by removing the brackets, bolts, and screws holding the station to the skid, then remove the screws to disconnect the ends of the skid.

The station has two on-site items required for the adjustable base to function.

After the cable ties have been removed and the power cable is plugged in for the unit. The NU-620 can be raised onto its lift system and rolled away from the end of the skid. It will take 5-10 seconds of holding the UP bottom for the lift to begin to move for the first time.

5.3 Plumbing Services

Typically, the NU-620 is not provided with plumbing services. In special cases, ground key cocks, needle valve cocks, or customer specified watering system hardware can be added. If ground key cocks are added, the type of service would be specified by the removable button on the handle. The ground key cocks are not recommended for pressure over 30 psi (2.0 BAR). Reducing valves should be installed external to the station if necessary. Ground key cocks should never be used for oxygen service. A special needle for oxygen service is required and available upon request.

External connection is to 3/8 inch NPT coupling in the inner sidewalls. Plugged clearance holes in the outer sidewalls are provided for easy access to the inner couplings via a NPT nipple. Connection to plant utilities should be made with proper materials for the individual service and according to national and/or local codes. It is not recommended that flammable gases be used in the station. However, if flammable gas is used, emergency shut-off valves should be located in an accessible area external to the station. Observe all labels pertaining to the type of service and operating pressure.

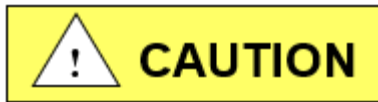

**THIS UNIT HAS NOT BEEN EVALUATED FOR USE WITH
FLAMMABLE, TOXIC OR EXPLOSIVE SUBSTANCES.
USE AT YOUR OWN RISK.**

5.4 Electrical Services

The NU-620 is provided with an electrical power cord. The station requires 115 VAC, single phase power and is recommended to be on its own branch circuit, protected with a 15 Amp circuit breaker at the distribution panel.

NOTE: THIS UNIT CONTAINS ELECTRONIC BALLASTS FOR FLUORESCENT/LED LIGHTING. ELECTRONIC BALLASTS OPERATE WITH HIGH INRUSH CURRENT. IT IS NOT RECOMMENDED TO USE THIS PRODUCT WITH GROUND FAULT INTERRUPTERS (GFCI'S) BECAUSE THE BALLASTS MAY CAUSE THE GFCI TO TRIP.

5.5 Certification

After installation and prior to use, NuAire recommends that the station be recertified to factory standards. At a minimum, the following tests should be performed (see Section 8.5).

1. HEPA Filter Integrity/Housing & Frame Leak Test
2. Downflow Air Velocity Measurement
3. Exhaust Motor/Blower Setup

It is recommended that these tests be performed by a qualified technician who is familiar with the methods and procedures for certifying Biosafety Cabinets.

After the initial certification, NuAire recommends that the station be recertified at a minimum on an annual basis and after every filter change or maintenance action or any time the operator feels it is necessary. Note that NuAire Animal Transfer Stations provide premium performance and superior reliability. However, protection of personnel and products is of utmost importance and it is highly recommended that certifications are completed as stated to ensure consistent conformance to factory standards

AllerGard™ ES Energy Saver
Containment Small Animal Transfer Station
Models
NU-620-300/400/500
NU-621-300/400/500

Model Number	Model Number		
	NU-620-300 NU-621-300 Nominal 3 foot (0.9m)	NU-620-400 NU-621-400 Nominal 4 foot (1.2m)	NU-620-500 NU-621-500 Nominal 5 foot (1.5m)
Performance Specifications NU-620 Product / Personnel NU-621 Product / Personnel	ISO 4 / Improved Allergen ISO 4 / NSF/ANSI 49	ISO 4 / Improved Allergen ISO 4 / NSF/ANSI 49	ISO 4 / Improved Allergen ISO 4 / NSF/ANSI 49
Diffuser for Air Supply (Metal)	Non-flammable	Non-flammable	Non-flammable
Supply Filter-99.99% Eff. on 0.3 microns Exhaust Filter-99.99% Eff. on 0.3 microns	Neoprene, Spring-loaded	Neoprene, Spring-loaded	Neoprene, Spring-loaded
Fumigation : per NIH/NSF Procedures	Yes	Yes	Yes
Standard Services: Duplex Outlet	One Sidewall	One Sidewall	One Sidewall
Optional Services: Gas Cocks 3/8" NPT	Up to 3 ea. Sidewall	Up to 3 ea. Sidewall	Up to 3 ea. Sidewall
Optional Services: Folding Shelf (Either Side)	14 (355) X 30 (762)	14 (355) X 30 (762)	14 (355) X 30 (762)
Cabinet Size Inches (mm): Height (Fully Assembled, minimum) Height (Fully Assembled, maximum) Height (Minimum for Transport without Castors) Width (with handles) Depth	80 ½ (2045) 92 ½ (2350) 75 (1905) 48 (1220) 30 5/8 (777)	80 ½ (2045) 92 ½ (2350) 75 (1905) 54 (1372) 30 5/8 (777)	80 ½ (2045) 92 ½ (2350) 75 (1905) 66 (1677) 30 5/8 (777)
Work Access Opening Inches (mm): Standard Opening Height	14 (356)	14 (356)	14 (356)
Work Zone Inches (mm): Height Width Depth	25 ½ (648) 36 5/8 (929) 28 ¼ (718)	25 ½ (648) 42 5/8 (1081) 28 ¼ (718)	25 ½ (648) 54 5/8 (1387) 28 ¼ (718)
Viewing Window Inches (mm):	Polycarbonate	Polycarbonate	Polycarbonate
Heat Rejected, BTU, Per Hour	785	785	785
Electrical: Volts, AC 60 Hz +Amps: Blower/Lights Amps: Duplex Rated Amps: 20 ft. (6.09m) Power Cord	U.L./U.L.-C Listed 115 5.0 3 12 Cord Reel-15A	U.L./U.L.-C Listed 115 5.5 3 12 Cord Reel-15A	U.L./U.L.-C Listed 115 6.0 3 12 Cord Reel-15A
Crated Shipping Weight:*** Net Weight	480 lbs. /218 kg. 430 lbs. /195 kg.	510 lbs. /231 kg. 460 lbs. /209 kg.	580 lbs. /263 kg. 530 lbs. /240 kg.

***Crated shipping weight does not include weight for accessories or options

+ Based on cabinet with new filters running at 115VAC.

6.0 Operating the NU-620

6.1 Aeromax™ Control System

6.1.1 Overview

The Aeromax™ control system is designed to service the control requirements of the NU-620. The Aeromax™ control system consists of an electronic module that will perform the following functions:

- Easy user interface via LED's and function keys
- Control blower via solid state switch.
- Control lights via solid state switch.
- Control outlets via solid state switch.
- Disable audible alarm switch with ring back function.
- Control blower DC ECM motor with solid-state DC Motor Controller that provides automatic compensation for line voltage variances.
- Monitor and display airflow system performance via PresurFlow™ monitor.

The NU-620 offers the latest digital microprocessor design technology for improved cabinet performance and safety. The Aeromax™ control system integrates a digital pressure sensor (PresurFlow™) to monitor the cabinet's airflow performance. The Aeromax™ control system also integrates a DC motor controller that provides automatic compensation for line voltage variances. There is additional on/off control of blower, fluorescent/LED light, ultraviolet light (optional) and outlets. All the above functions are shown in a system block diagram (see figure 1).

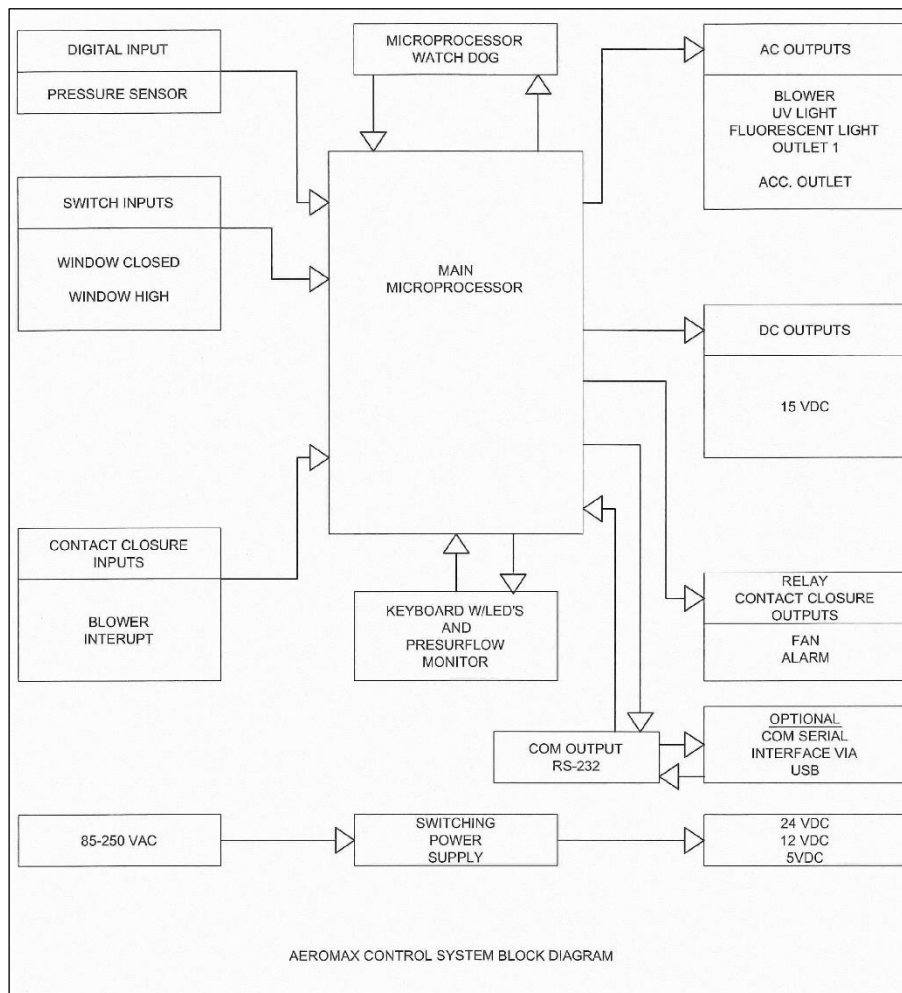
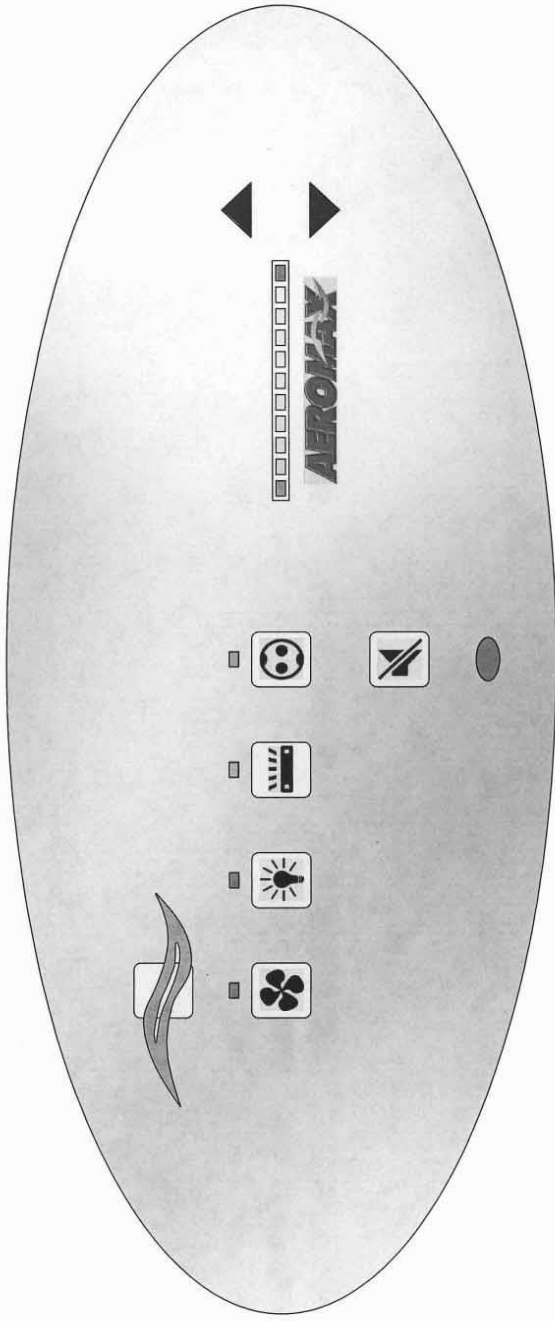



Figure 1

REV	ECO	DESCRIPTION	DATE	DFTM	CHKD
C	13471	UPDATED TITLE	8/25/2017	TH	BP



 ORIGINAL						
TITLE						
AEROMAX FRONT PANEL						
DFTM	DATE	CHKD	SHEET	1	OF	1
LS	12/16/2013	BP				
DRAWING		BCD-16521		C		
NUMBER						

6.1.2 Front Panel

The control system front panel contains the following functions described in detail (see Drawing BCD-16521).

6.1.2.1 Blower Keys

The blower key controls the ON/OFF power to the blower.
LED above key indicates: full green for blower on,
blinking green for blower pending and
full red for blower alarm.

6.1.2.2 Hidden Key

The hidden key is located just above the blower LED indicator centered in the airflow symbol. The hidden key is used for various functions including the blower password 3 key sequence if the option is activated.

6.1.2.3 LED Light Key

The LED light key controls the on/off power to the LED light.
LED above the key indicates full blue for fluorescent light on.

6.1.2.4 Ultraviolet (UV) Light Key (Typically Not Used on this model)

6.1.2.5 Outlet Keys

The outlet key controls the ON/OFF power to the outlet.
LED above indicates full blue for outlets on.

6.1.2.6 Red Alarm LED

The red alarm LED will indicate any alarm condition and remain indicating until the alarm condition is cleared.

6.1.2.7 Audible Alarm Silence

The audible alarm silence key allows user interaction to silence an audible alarm for a period of 15 minutes. After 15 minutes if the alarm condition still exists, the audible alarm will again sound. The audible alarm silence key also is used to exit all Aeromax™ user interaction menus.

6.1.2.8 Arrow Adjustment Keys

The arrow adjustment keys allow user interaction for various functions.

6.1.3 Aeromax™ Control System Power

After the NU-620 is plugged into the appropriate facility line power the control system will power up. The control panel will also indicate the power up status by blinking the red alarm LED. Pressing any key will acknowledge the power up status and turn off the blinking red alarm LED.

If a power interruption occurs, all control system functions, calibrations and parameters will be maintained and continue upon restoration of power. During the initial power up, the red alarm LED will blink to indicate power up status.

6.1.4 Standby Mode

When the ATS is not in use any of the function keys except the blower that initiates run mode may be turned on and off in standby mode.

6.1.5 Run Mode

Any time the blower run key is pressed with the window at its correct operational height, the Run Mode screen will be initiated. While in Run Mode one LED segment will be illuminated to indicate cabinet airflow status. Wait for at least one minute after starting the blower for the airflow to stabilize before starting any work.

Once stabilized, the single illuminated LED will indicate the following:

- Green: Unit airflow is within safe working parameters.
- Yellow: Unit airflow is within safe working parameters, but near unsafe limits.
Consider recalibration/recertification.
- Red: Unit airflows are not safe and unit should not be used.
Check airflow values and recalibrate/recertify cabinet. See section 7.1.

Note: When first setting the motor control function parameter (section 8.5.2) the PresurFlow™ system will enter an approximate 3 minute warm up period. If the blower is turned on during this period the PresurFlow™ LED indicators will blink and indicate the following sequence:

- 1st minute – Left and right Red LED's will blink
- 2nd minute – Left and right Green LED's will blink
- 3rd minute – Center 3 Green LED's will blink

Once the warm-up period is complete, only one LED will indicate cabinet airflow status.

6.1.6 Standby/Run Mode Alarms

If present, standby/run mode alarms will be both visual and audible, the red alarm LED oval will turn on. Audible alarms will produce an alarm tone for 30 seconds, then ring back for 2 seconds of every 5 seconds. Pressing the alarm silence key will silence the audible alarm for 15 minutes initially then will start the ring back function again.

The list below represents alarm types and their respective priority from the highest to lowest priority.



- 1) New Firmware Loaded
- 2) Internal Board Failure
- 3) Power on Reset
- 4) Airflow Pressure Alarm
- 5) Blower RPM Failure

Note: The above messages are described in greater detail in section 10.0.

6.1.7 Operator Accessible Functions

6.1.7.1 Access and Navigation



To access the operator accessible functions,





- Press and hold the  key, then enter the 3-key sequence for the desired function, then release the  key and follow each instruction set.

Note: Pressing the  key at any time will abort and exit the process without saving any changes made. Pressing the hidden key will accept all changes and exit.

6.1.7.2 Auto Timer Duration

Auto timer duration timers are countdown timers for the functions displayed once time is entered into a function. The timer will begin to countdown upon the start of that function (i.e. press UV light key to start timing the UV light). The LED indicator above the function key will start to blink indicating the timer function. If the LED indicator was full on, no timer function is present. As the timer expires the function will turn off.

- Select auto timer duration function
 - Outlets
Press and hold  key, then press hidden – outlet – outlet keys sequentially. LED indicator above outlet will blink fast. Adjust desired time as described below.
 - Lights
Press and hold  key, then press hidden – light – light keys sequentially. LED indicator above light will blink fast. Adjust desired time as described below.
 - Adjust countdown time
Press \uparrow or \downarrow keys to adjust time. Time will change in 15-minute increments as shown on the PresurFlow™ LED segments below.

Time in Increments	LED Display
15 minutes for Red LED	
30 Minutes for Yellow LED	
1 hour for green LED	
Represents 8 hours (maximum time)	

- Press hidden key to accept time and exit.
- Press  key at any time to abort and exit.

6.1.7.3 Blower Password

The blower on/off password allows the cabinet user to place a 3 key sequence requirement to turn the blower on or off.







The 3-key sequence for the blower password will be a combination of the hidden and blower keys.

- Select blower password

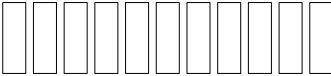
Press and hold  key, then press hidden – blower – hidden keys sequentially. Red LED indicator above blower will blink fast.

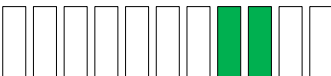
- Select password

Press \uparrow or \downarrow key to scroll through the code choices below,

	No Password
	B-B-H password
	B-H-B password (default)
	B-H-H password only
	H-B-B password
	H-B-H password
	H-H-B password

- Press hidden key to accept time and exit.
- Press  key at any time to abort and exit.

Note: If the required blower password option is selected in the blower airflow option menu (see section 8.2.2). Then the “No password” choice above is not available and the default remains B-H-B.

7.0 Operating Guidelines

It is acceptable and sometimes recommended to operate the station continuously. The station will then remain in its initially clean condition. If for any reason the unit is turned off for some time, daily or weekly, turn the station on and run for 10 minutes before using.

Allow only essential items in the work station. New items introduced into the work area should be placed within one of the worksurface quadrants to minimize cross contamination. All work should be performed with the operator's hand downstream of the critical process points. Unnecessary movement with the work station should be kept to a minimum.

7.1 Operating Sequence:

Start-Up

Turn on the station's blower and lights. Blower speed must only be readjusted by qualified maintenance technicians. Good procedure includes the decontamination or wipe down of station surfaces with chemical disinfectant before work commences.

Note: See cleaning procedures section 7.3

Allow blower to operate for a minimum of 10 minutes before aseptic manipulations are begun in the station. An additional advantage is obtained from purification (filtration) of the room air circulated through the equipment. Because of the characteristics contributed to the quality of the laboratory environment, some owners leave them in operation beyond the time of actual use.

Minimize Room Activity

Activity in the room itself should be held to a minimum. Unnecessary activity may create disruptive air currents as well as interfere with the work of the operator. A person walking past the front of the station can cause draft velocities up to 175fpm (.88 m/s) which are sufficient to disrupt the air balance of the Laminar Flow Unit.

Utilize Unidirectional Airflow

The operator must keep two important facts in mind:

1. The air is supplied to the work area through the HEPA filter is contaminant free.
2. Airborne contamination generated in the work area is controlled by the unidirectional vertical flow air stream.
A solid object placed in a laminar air stream will disrupt the parallel flow and consequently, the capability of controlling lateral movement of airborne particulates. A cone of turbulence extends behind the object and laminarity of the air stream is not regained until a point is reached downstream, approximately equal to three to six times the diameter of the object. Within the parameters of this cone, particles may be carried laterally by multidirectional eddy currents. The downdraft vacuum source on the worksurface greatly reduces the above effect. However, working with proper technique is always the best method.

Terminal Purging & Wipe down

Following completion of the work, allow the station for a 2-3 minute period without personnel activity to purge the unit. The decontamination of the interior surfaces should be repeated after removal of all work materials.

Prefilters

Located under the work surface is a prefilter area. This area forms the air path to the exhaust motor/blower. If the air flow is blocked by excessive animal dander or bedding materials, the performance of the station could be seriously affected. Therefore, **THE PREFILTERS SHOULD BE CHECKED AND CLEANED NO LESS THAN ON A WEEKLY BASIS.** The prefilters may be vacuumed to remove the materials. The prefilters may also be replaced as necessary (see replacement parts list).

Shut Down

Turn off blowers and lights. Do not use station as a depository for excess laboratory equipment during periods of non-operation.

7.2 Ergonomics

Ergonomics, the study or accommodation of work practices is extremely important for proper usage and user health and safety. An evaluation of normal work practices should be performed with each user when working. Evaluation criteria should be at a minimum:

- a. Proper user posture (sitting or standing)
- b. Effective work zone layout for work practice
- c. Vision or sightlines

For each of the above evaluation criterion, several aids may be supplied to accommodate the user.

- Ergonomic chair – for sitting application, a six-way articulating seat and back control for personalized adjustment to assure proper user posture. Be sure feet are resting on the floor, chair foot support or foot rest. Also be sure back is fully supported with proper chair adjustments.
- Anti-fatigue mat – for standing application, using a closed cell skinned anti-fatigue mat will aid user comfort.
- Forearm/armrest support - The cabinet is provided with a forearm support on the work access opening. Periodic mini-breaks during work practice should be taken resting forearm to avoid stress and fatigue.
- Effective work zone layout - Always prepare your work procedure to minimize reach to avoid neck and shoulder stress and fatigue. Rotating tables are optional to maximum work zone and minimize reach.
- Vision and sightline - Always prepare your work procedure to eliminate glare and bright reflections on the window. Keep your window clean and sightlines clear to your effect work zone.

7.3 Cleaning Procedures

7.3.1 General

Cleaning laboratory equipment is important in terms of both functionality and general good housekeeping. The information provided below is intended to aid the development of facility Standard Operating Procedures (SOP's) for cleaning the equipment. It is strongly recommended that all cleaning materials used be tested and verified in terms of both effectiveness and material compatibility before they are written into the cleaning SOP documentation.

a. The airflow blower should be operating during the cleaning process to maintain sterility and/or containment during the cleaning process.

b. Raise window to gain additional access if desired.

c. Apply appropriate cleaning material or surface disinfectant to surfaces. Most surface disinfectants require a specific contact time depending the materials used within the work zone. **CONSULT APPROPRIATE DISINFECTANT DOCUMENTATION FOR PROPER APPLICATION AND SAFETY PRECAUTIONS.**

c-1. Polycarbonate (Covestro® Makrolon®AR) has noted material compatibility concerns (see polycarbonate compatibility section). They recommend the use of Hydrogen Peroxide based materials such as the following:

- Steriplex SD
- Safetec surface wipes
- Peridox RTU

It is recommended to AVOID the use of cleaning materials that contain Chlorine, Quaternary Ammoniums and Phenol's.

If the polycarbonate is lightly scratched, it may be able to be polished out with Mirror Glaze Plastic Polish or similar.

Further information may be available from www.covestro.com

c-2. Stainless steel (type 304) has noted material compatibility concerns with Acids, Chlorides and Halogens. **IF THESE MATERIALS ARE USED AND ALLOWED TO BE LEFT ON THE STAINLESS STEEL SURFACE, OXIDATION AND DEGRADATION WILL OCCUR.** Only by re-wiping surfaces with either sterile water or 70% IPA will remove harmful materials from the stainless steel surface.

Further information is available at the following:

http://www.parrinst.com/wp-content/uploads/downloads/2011/07/Parr_Stainless-Steels-Corrosion-Info.pdf

NOTE: NuAire does not offer any product warranty with respect to cleaning material compatibility. USE AT YOUR OWN RISK! The information provided above is from raw material suppliers and known general source documents for use to develop application cleaning SOP's.

NOTE: When cleaning the work area for the first several times, the new metal surfaces may produce some dark discoloration on the white cleaning wipes. Repeated cleaning will continuously reduce the amount of the discoloration material on the cleaning wipes over time.

8.0 General Maintenance



All maintenance actions on this equipment must be performed by a qualified technician who is familiar with the proper maintenance procedures required for this equipment. This includes both certification as well as repair.

Normally, no preventative maintenance is required on the interior of the station. The motor is lubricated for life and is thermally protected with automatic reset. The entire lamp assembly is located under the removable supply diffuser. Motor controls and station switches are located in the clean area of the hood.

However, it is recommended to perform routine preventative maintenance. Additionally, it is recommended that the station be certified, per section 8.7 after the station has been installed and annually thereafter, or whenever the operator has reason to believe it necessary.

8.1 Preventative Maintenance

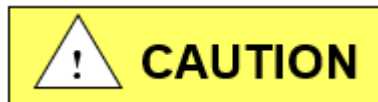

In addition to the annual certification process it is recommended that the following preventative maintenance be performed on a regular basis to ensure the station remains in safe working order.

8.1.1 Prefilters

The prefilters should be inspected daily and cleaned on a regular basis as needed or in accordance with established facility guidelines and SOP's. This will ensure that proper airflows will be maintained.

8.1.2 Hydraulic Lift

The hydraulic lift should be inspected annually by running it fully up and down and observing for proper operation.

8.1.3 Caster Channel

The channels that secure the casters to the stainless steel hydraulic legs should be checked annually for tightness to the hydraulic leg. If they are bent or loose replacement may be necessary.

8.1.4 Casters

The casters should be inspected annually for tightness. If they are found to be loose, they should be removed, inspected and re-installed with BLUE Loctite. If they are bent or loose replacement may be necessary, please contact NuAire's Technical Support 1-800-328-3352.

8.1.5 Push\Pull Bars

The push\pull bars should be inspected annually and tightened as necessary. There are two nuts that secure them to the cabinet. They are under a cover on the black end pieces. They can be tightened with a 7/16" socket or nut driver.

8.1.6 Power Cord

The power cord itself should be inspected for wear on an annual basis.

8.2 LED Lamp Replacement

8.2.1 To Replace a Lamp:

- 1) Switch the station light off.
- 2) Raise hinged window to access supply diffuser.
- 3) Remove supply diffuser via fasteners.
- 4) The LED lamps are removed by rotating the lamp until the pins are free to be gently pulled from the tombstones
- 5) Reverse the above procedures to replace the lamp and reassemble the station.

8.3 HEPA Filter Replacement

It is recommended that the station have the integrity of the HEPA filters verified by a qualified technician after the unit has been initially installed. Thereafter, certification per Section 8.5 should be performed on an annual basis or whenever the operator has reason to believe it is necessary. The HEPA filters under normal usage and barring an accident do not need replacement until the efflux velocity cannot be maintained.

8.3.1 Supply HEPA Filter

- 1) Disconnect electrical power from station.
- 2) Remove side filter access cover from station's top housing via fasteners.
- 3) Raise hinged window to access supply diffuser.
- 4) Remove supply diffuser via fasteners.
- 5) Loosen filter frame hold down spring clamps under filter.
- 6) Once filter is loose, pull out HEPA filter from side access using handles provided.
- 7) When replacing the filter, **use only filters of the same rated flow, pressure drop and size.**
- 8) To install new filter, grease the top gasket of the filter with silicon grease and carefully install onto filter frame.
- 9) Tighten filter frame hold down spring clamps evenly, so filter gasket will have equal pressure from all areas.
- 10) Replace diffuser and side access cover once filter is installed.

8.3.2 Exhaust HEPA Filter

- 1) Raise station to its highest available work height.
- 2) Disconnect electrical power from station.
- 3) Remove protective screen under exhaust HEPA filter via fasteners.
- 4) Loosen filter frame hold down spring clamps under filter.
- 5) Remove the (2) two center bolts, springs and washers.
- 6) Remove the (2) two right side bolts, springs and washers and lower right side of filter rack to rest on cross bar.
- 7) Slide filter out right side of unit.
- 8) When replacing the filter, **use only filters of the same rated flow, pressure drop, and size.**
- 9) To install new filter, grease the top gasket of the filter with silicone grease and carefully install onto filter frame.
- 10) Tighten filter frame hold down spring clamps evenly, so filter gasket will have equal pressure from all areas.
- 11) Replace protective screen, side access cover, and filter access cover once filter is installed.

<u>USE ONLY NUAIRE SPECIFIED FILTERS FOR REPLACEMENT</u>		
Description:	Supply HEPA Filter	Exhaust HEPA Filter
Efficiency:	99.99% @ 0.3 Micron	99.99% @ 0.3 Micron
Airflow Rating:	100 fpm @ .35 ± .05" w.g. per sq. ft.	100 fpm @ .35 ± .05" w.g. per sq. ft.
Frame Type:	Metal	Metal
<u>NU-620/621-300</u>		
NuAire Part Number:	A-980980-04	A-980980-01
Filter Size:	20" (508mm) x 38" (965mm) x 3" (76mm)	18" (457mm) x 34" (864mm) x 3" (76mm)
<u>NU-620/621-400</u>		
NuAire Part Number:	A-980980-05	A-980980-02
Filter Size:	20" (508mm) x 44" (1118mm) x 3" (76mm)	18" (457mm) x 40" (1016mm) x 3" (76mm)
<u>NU-620/621-500</u>		
NuAire Part Number:	A-980980-06	A-980980-03
Filter Size:	20" (508mm) x 56" (1422mm) x 3" (76mm)	18" (457mm) x 52" (1321mm) x 3" (76mm)

8.4 Motor/Blower Replacement

The motor/blower assemblies should never need any preventative maintenance, but in case of a malfunction, the following steps should be taken.

- 1) Disconnect electrical power from station.
- 2) To remove the lower (exhaust) motor/blower, lift and remove the work tray and the prefilter screen assembly. Then, remove the nuts that secure the blower plate to the station, lift out the plate and motor/blower, and disconnect the wire harness and ground cable. To remove the upper (supply) motor/blower, remove the prefilter assembly. Then lift the plate with the motor/blower and disconnect the wire harness and ground cable.
- 3) Re-assemble by reversing the above steps.





8.5 Airflow Control System Setup and Calibration

8.5.1 General

The operation of the NU-620 cabinet requires that the setup and calibration procedures be performed in order to certify or commission the cabinet for usage. The setup and calibration procedures performed **ONLY BY THE CABINET CERTIFIER** ensure that cabinet's setpoints are verified and that the airflow monitor sensor is calibrated to the correct values.

8.5.2 Configuration Parameters

Configuration parameters identify cabinet motor type and size for proper performance characteristics.

- Select motor control function/type
 - Press and hold  key, then press light – light – light keys sequentially. LED indicators above both blower (red) and light keys will blink fast. Review motor control function/type and change it desired as described below.
 - Press ↑ or ↓ keys to scroll through the LED segment choices associated with motor control function/type.
 -  Auto DC ECM motor
 -  Fixed duty DC ECM motor
 -  Fixed duty EC Impeller motor
 - Press hidden key to accept motor control function/type and exit
 - Press  key at any time to abort and exit.

8.6 Airflow Calibration



Failure to calibrate airflow to the specified requirements may result in unsafe conditions of performance (i.e. product and/or personnel protection, noise and vibration)

The NU-620 airflow calibration consists of airflow adjustments within the station.

NOTE: THIS WORK SHOULD BE DONE ONLY BY A QUALIFIED TECHNICIAN WHO CAN MEASURE VOLTAGE AND AIRFLOW FROM THE FILTERS WITH A SUITABLE VELOMETER.

Airflow is adjusted by changing blower voltage regulator settings.

The station is considered to be certifiable if the following measurements are present:

a. Downflow Average: 60 ± 5 LFPM ($.3 \text{ m/s} \pm .025 \text{ m/s}$)

	Single Side	Model
b. Exhaust Airflow	550 ± 50 CFM (935 ± 85 CMH)	621-300
	625 ± 50 CFM (1060 ± 85 CMH)	621-400
	800 ± 50 CFM (1360 ± 85 CMH)	621-500
	Dual Side	Model
	425 ± 50 CFM (720 ± 85 CMH)	620-300
	500 ± 50 CFM (850 ± 85 CMH)	620-400
	600 ± 50 CFM (1020 ± 85 CMH)	620-500

NOTE: BEFORE STARTING AIRFLOW CALIBRATION PROCEDURE, LET THE STATION RUN FOR AT LEAST 10 MINUTES.

8.6.1 Downflow Calibration

Step 1: Place an anemometer in the station work zone in a parallel plane 2 inches (51mm) from the supply diffuser surface. Spot check several points on the recommended downflow velocity test grid found in Table 10.

Step 2: If necessary, adjust supply airflow via the standalone potentiometer in the control center, to the above stated airflow requirements.

Table 10 Recommended Measurement Method for Downflow Calibration

NU-620/621-300						
	6 (152)	11 (279)	16 (406)	21 (533)	26 (660)	31 (787)
8 (203)						
20 (508)						

NU-620/621-400							
	6 (152)	11 (279)	16 (406)	21 (533)	26 (660)	31 (787)	36 (914)
8 (203)							
20 (508)							

NU-620/621-500								
	6 (152)	12 (305)	18 (457)	24 (610)	30 (762)	36 (914)	42 (1067)	44 (1219)
8 (203)								
20 (508)								

Number of Readings:	Average Velocity:	LFPM (m/s)
---------------------	-------------------	------------

8.6.2 Exhaust Airflow

Procedure:

After downflow calibration is complete, remove the work surface but leave the black prefilters in place. Then place a direct inflow-measuring device (with the hood removed) over the opening to the exhaust impeller. Seal the opening around the base of the DIM with duct tape.

If necessary, enter active blower speed adjustment.

- Press and hold  key, then press hidden – blower - ↑ keys sequentially. LED indicator above blower (green) key will blink fast.

Press ↑ or ↓ keys to adjust blower speed.

- LED segments will indicate blower speed percentage and active blower speed adjustment.



- Right end red LED indicates active blower speed adjustment . The red LED will blink as soon as any adjustments are made and will continue to blink as the motor rpm settles. Once the red LED stops blinking, the motor will run steady state at the new percentage.

Note: The red LED must be non-blinking to save or exit

- Green LED's indicate percentage on of scale (0-100%)
- Yellow LED's indicate minimum (left/maximum (right) blower speed has been achieved

Note: At any time during the process

- Press hidden key to accept and enter the blower speed calibration point (if the blower speed calibration point was not successfully entered, a half second audible alarm will occur. The calibration process must then be repeated for successful entry of blower speed calibration point.)
- Press  key to abort and exit

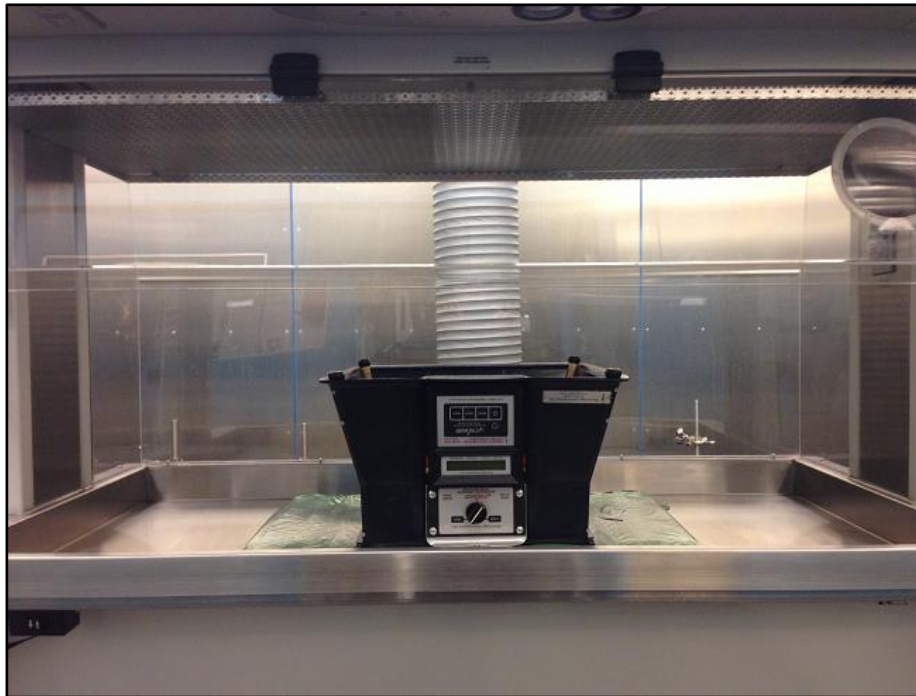

Alternate Method:

After downflow calibration is complete, remove the work surface, stainless steel drip cover, and the mesh screen with the elastic band in the exhaust plenum (leave the black prefilters in place). Then place an 18" x 18" x 12" cardboard box (with bottom removed) around the opening. Add a hole at the center of the front of the box (6 inches from the bottom, 9 inches from the side). Create a fixture to hold a thermo anemometer probe, and take 11 readings across the opening starting 4 inches from inside of box, reading 1-inch apart, until probe end is 14 inches from inside edge of the box. Average the 11 readings, (compensate for the local air density), multiply the average by the area, (2.25 ft²) and then multiply by the conversion factor .68.

8.7 Filter Integrity Check

In order to check the filter, the HEPA filter media must be directly accessible. Remove the supply diffuser and exhaust protective screen to access the filters. P.A.O. upstream concentration ports are available on both the top and bottom filter housings if needed.

NOTE: Scanning the HEPA filter seal cannot be done by only removing the diffuser screen. HEPA filtered air must be directed into the dead-air space to flush the area with particle free air while scanning for leaks. The frame itself is under negative pressure and scavenger slots, if present, help flush out the area when the diffuser is installed.

For more information reference STB0374 HEPA Filter Frame Area Testing.

8.8 PresurFlow™ Alarm Set Points

The PresurFlow™ alarm setpoints are preset based on the calibration setpoint. Once the calibration setpoint is entered, based on a nominal airflow velocity, the associated pressure sensor value is entered as the nominal pressure value. The high and low alarm setpoints are preset with an associated pressure offset value within the acceptable cabinet airflow range. Normally, no further adjustment is needed.

However, if specific use alarm setpoints are desired, the alarm setpoints may be adjusted by performing the following:

Low Alarm Setpoint

- Press and hold the Hidden and ↓ key for 3 seconds.
(The left red LED will blink and the green LED's indicate blower speed)
- Press ↑ or ↓ keys to adjust blower speed to the desired airflow velocity low alarm setpoint value.

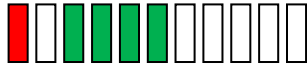

- Left end red LED indicates active low limit blower speed adjust
The red LED will blink as soon as any adjustments are made and will continue to blink as the motor rpm settles. Once the red LED stops blinking, the motor will run steady state at the new percentage. If the low alarm setpoint value is not within an acceptable range, the left end red LED will blink at a very fast rate.

Note: The red LED must be non-blinking to save or exit.

Note: At any time during the process

- Press hidden key to accept low alarm setpoint value
- Press  key to abort and exit
- Upon exiting, the blower will go back to actual airflows.

High Alarm Setpoint

- Press and hold the Hidden and ↑ key for 3 seconds.
(The right red LED will blink and the green LED's indicate blower speed)
- Press ↑ or ↓ keys to adjust blower speed to the desired airflow velocity high alarm setpoint value.



- Red end Red LED indicates active high limit blower speed adjust.
The red LED will blink as soon as any adjustments are made and will continue to blink as the motor rpm settles. Once the red LED stops blinking, the motor will run steady state at the new percentage. If the high alarm setpoint value is not within an acceptable range, the right end red LED will blink at a very fast rate.

Note: The red LED must be non-blinking to save or exit.

Note: At any time during the process

- Press hidden key to accept low alarm setpoint value
- Press  key to abort and exit
- Upon exiting, the blower will go back to actual airflows.

Note: Specific use alarm setpoints will be lost upon entry of new nominal calibration value. It is necessary to re-enter specific use high/low alarm setpoints every time a new nominal calibration is entered.

8.9 Decontamination

No maintenance should be performed on the interior of the Allergard cabinet (area behind access panels) unless the cabinet has been microbiologically decontaminated, is known to be biologically clean, or known to be chemically inert.

If microbiological decontamination is necessary, use the following procedure:

1. Place decontamination equipment inside the work area. Reference decontamination procedure (per NSF Standard 49-2022 Annex I-2 or EN 12469:2000 Annex J), using the following chart to calculate chemical requirements.

Model	NU-620/621-300	NU-620/621-400	NU-620/621-500
Cabinet dimensions	75.375 x 42 x 30.625 in. (1.91 x 1.1 x .8 m)	75.375 x 48 x 30.625 in. (1.91 x 1.2 x .8 m)	75.375 x 60 x 30.625 in. (1.91 x 1.5 x .8 m)
Cabinet volume	60 ft ² (1.68 m ²)	68 ft ² (1.83 m ²)	86 ft ² (2.29 m ²)

2. Seal entire unit to floor using plastic and tape.
Allow access to cabinet power cord to operate fan during decontamination procedure.

CAUTION: BE SURE CABINET IS TOTALLY SEALED TO PREVENT ANY LABORATORY EXPOSURE TO DECONTAMINATION GAS.

3. Perform decontamination procedure per NSF Standard 49 Annex I-2 or EN 12469:2000 Annex J.

Environmental resistance of Makrolon® polycarbonate sheet

Makrolon® POLYCARBONATE SHEET IS RESISTANT AT 70°F AND 0% STRAIN TO:

CHEMICALS:

Amyl Alcohol	Chromic Acid (20%)	Lactic Acid (20%)	Potassium Bromate	Sodium Chloride
Aluminum Chloride	Citric Acid (40%)	Magnesium Chloride	Potassium Bromide	Sodium Hypochlorite
Aluminum Sulfate	Copper Chloride	Magnesium Sulfate	Potassium Nitrate	Sodium Sulfate
Ammonium Chloride	Copper Sulfate	Manganese Sulfate	Potassium Perchlorate	Stannous Chloride
Ammonium Nitrate	Formic Acid (10%)	Mercuric Chloride	Potassium Permanganate	Sulfur
Ammonium Sulfate	Formalin (30%)	Nickel Sulfate	Potassium Persulfate	Sulfuric Acid (10%)*
Antimony Trichloride	Glycerine	Nitric Acid (10%)	Potassium Sulfate	Sulfuric Acid (50%)
Arsenic Acid	Heptane	Nitric Acid (20%)	Silicone Oil	Tartaric Acid (30%)
Butyl Alcohol	Hydrochloric Acid (10%)	Oleic Acid	Silver Nitrate	Zinc Chloride
Calcium Nitrate	Hydrogen Peroxide (30%)	Oxalic acid	Sodium Bicarbonate	Zinc Sulfate
Chlorinated Lime Paste	Hydrofluoric Acid (10%)	Pentane	Sodium Bisulfate	
Chrome Alum	Isopropanol	Phosphoric Acid (10%)	Sodium Carbonate	

*Sulfuric Acid at 1% attacks polycarbonate sheet

COMMON HOUSEHOLD MATERIALS Makrolon® POLYCARBONATE IS RESISTANT TO:

CHEMICALS:

Borax	Joy Liquid Detergent	Rum
Cocoa	Insulating Tape	Salad Oil
Cement	Linseed Oil	Salt Solution (10%)
Chocolate	Liquor	Soap (Soft/Hard)
Cod Liver Oil	Milk	Table Vinegar
Cognac	Mineral Water	Tincture of Iodine (5%)
Coffee	Mustard	Tomato Juice
Detergents	Olive Oil	Vodka
Fish Oil	Onions	Washing Soap
Fruit Syrup	Orange Juice	Water
Grapefruit Juice	Paraffin Oil	Wine
Gypsum	Rapeseed Oil	

PETROLEUM PRODUCTS Makrolon® POLYCARBONATE SHEET IS RESISTANT TO:

Compressor Oil	Spindle Oil
Diesel Oil	Transformer Oil
Kerosene	Vacuum Pump Oil
Refined Oil	

Note: Elevated temperature and/or strain significantly alters resistance to industrial petroleum products.

LIMITED RESISTANCE AT 70°F AND 0% STRAIN TO:

Antifreeze	Hydrochloric Acid (conc.)
Calcium Chloride	Milk or Lime (CaOH)
Cyclohexanol	Nitric Acid (conc.)
Ethylene Glycol	Sulfuric Acid (conc.)

Makrolon® POLYCARBONATE SHEET IS NOT RESISTANT TO:

CHEMICALS:

Acetaldehyde	Benzyl Alcohol	Chlorobenzene	Formic Acid (conc.)	Phosphorus Trichloride
Acetic Acid (conc.)	Brake Fluid	Chloroethene	Freon (refrigerant/propellant)	Propionic Acid
Acetone	Bromobenzene	Cutting Oils	Gasoline	Sodium Sulfide
Acrylonitrile	Butylic Acid	Cyclo Hexanone	Lacquer Thinner	Sodium Hydroxide
Ammonia	Carbon Tetrachloride	Cyclohexene	Methyl Alcohol	Sodium Nitrate
Ammonium Fluoride	Carbon Disulfide	Dimethyl Formamide	Nitrobenzene	Tetrahydronaphthalene
Ammonium Hydroxide	Carbolic Acid	Ethane Tetrachloride	Nitrocellulose Lacquer	Thiophene
Ammonium Sulfide	Caustic Potash Sol. (5%)	Ethylamine	Ozone	Toluene
Benzene	Caustic Soda Sol. (5%)	Ethyl Ether	Phenol	Turpentine
Benzoic Acid	Chloride	Ethylene Chlorohydrin	Phosphorus Hydroxy	Xylene

Makrolon® POLYCARBONATE SHEET IS DISSOLVED BY:

Chloroform, Cresol, Dioxane, Ethylene Dichloride, Methylene Chloride, Pyridine

EFFECTS OF MOISTURE ON Makrolon® POLYCARBONATE SHEET:

Makrolon Polycarbonate Sheet has good resistance to water up to approximately 150°F. Above this temperature, the effect of moisture is time-temperature related. Exposing Makrolon Polycar-

bonate Sheet to repeated steam cleaning or dishwashing can create hydraulic crazing. The result can be a clouding of the surface and ultimately a loss of physical strength properties.

10.0 Error Indicators, Troubleshooting & Option Parameters

10.1 Error indicators occur for a variety of reasons.

Whenever an error indicator is presented, minihelic gauge not reading, or light doesn't come on, please perform the following:

Step 1: NOTE ALL ERROR INDICATORS.

When the station is running, note all functions that are in error.

Step 2: VERIFY ERROR INDICATOR.

Error indicators can be verified by turning the errored function on/off.

Step 3: MONITOR RE-OCCURRENCE OF ERROR INDICATORS.

If re-occurrence of the error indicator is immediate or daily, use guide below to correct the situation.

Error Indicator Troubleshooting Guide

Error Indicator	Indicator	Correction
Station lights won't turn on.		Check fuse on front of control board. Check bulbs. Check voltage to light ballast's. Check ballast. Check light switch.
Station blowers won't turn on.		Check fuse on control board. Check voltage to blower. At motor voltage regulator. Check wiring to blower. Check blower capacitor. Check blower motor.
Station outlets won't turn on.	Make sure blower key is turned on.	Check fuse on control board. Check voltage to outlets.
Blower/Lights/Outlet fuses continue to blow.		Check for short on main control board. Isolate output of circuit by disconnecting control center connectors, light circuit, AC or DC motor voltage, etc. to isolate the short.
Hydraulic Lift	Lift system does not function properly	Call NuAire Service to resolve. (1-800-328-3352)
PresurFlow™ left red LED indicator on and red LED alarm	PresurFlow™ reading low flow (pressure)	Check airflow values. Check blower function. Recalibrate PresurFlow™ system.
PresurFlow™ right red LED indicator on and red LED alarm	PresurFlow™ reading high flow (pressure)	Check airflow values. Recalibrate PresurFlow™ system.
All PresurFlow™ LED's blink	Message acknowledges new firmware was loaded into microprocessor	N/A
Blower red LED blinks and red LED alarm	Indicates that the motor rpm signal has been interrupted	Check connectors and wires from main control board to the exhaust motor Replace motor if required

10.2 Option Parameters

The option parameter menu allows **A QUALIFIED TECHNICIAN** to configure several different optional parameters per the menu as described below.

10.2.1 Sync Function with Active Blower

To access the option parameter menu, perform the following:

- Press and hold  key, then press hidden - Blower - Fluorescent keys sequentially. Red LED indicator above the blower key will blink fast

The PresurFlow™ blinking green LED segments will indicate seven optional parameters as shown and described below. The UV Light key (move left) and outlet key (move right) allows selection of the option parameter desired.

Once the desired option parameter is indicated, press \uparrow or \downarrow key to turn on or off. A slow blinking green LED indicator means off and a fast blinking green LED indicator means on. Multiple option changes can be selected.

- Pressing the hidden key will accept all changes and exit
- Pressing the  key will abort the process and exit



Sync Fan Relay with Active Blower -

Normally the fan relay will activate when the blower switch is pressed. Blower can either be actively running or pending. If the fan relay sync is active the blower must be actively running for the relay to change state.



Sync Accessory Outlet with Active Blower -

Normally the accessory outlet is on all the time. If the accessory outlet sync is active, the blower must be actively running for the accessory outlet to turn on.



Sync Outlet Power with Active Blower -

Normally the outlet power is turned on via the outlet key. If the outlet power sync is active, the outlet power will turn on and off with the blower or may be turned on and off independently if the blower is active.



Sync Fluorescent Light with Active Blower -

Normally the fluorescent light is turned on via the fluorescent light key. If the fluorescent light sync is active, the fluorescent light will turn on and off with the blower or may be turned on and off independently if the blower is active.



Sync 15 Volt DC output with active blower normally the 15 Volt DC output located on the control board is on when power is applied to the system. If the 15 Volt DC output sync is active, the blower must be actively running for the 15 Volt DC output to turn on.

10.2.2 Blower/Airflow Options

To access the option parameter menu, perform the following:

- Press and hold  key, then press hidden - \uparrow and \downarrow keys sequentially. Red LED indicator above the blower key will blink fast

The PresurFlow™ blinking green LED segments will indicate seven optional parameters as shown and described below.

The UV Light key (moves left) and outlet key (moves right) allows selection of the option parameter desired.

Once the desired option parameter is indicated, press \uparrow or \downarrow key to turn on or off. A slow blinking green LED indicator means off and a fast blinking green LED indicator means on. Multiple option changes can be selected.

- Pressing the hidden key will accept all changes and exit
- Pressing the  key will abort the process and exit



Require Password –

Normally it is not required to use a password (i.e. 3 key press sequence of the blower and hidden key). If the option is turned on, it would be required to use the correct password to turn on the blower. The default password once turned on is blower-hidden-blower keys in sequence. The password can be changed in the blower password option menu.



Allow UV light anytime –

Normally the UV light is interlocked with the window being in the closed position. For service purposes only, if the function is active, the UV light may be turned on at any window height.

Note: In addition to the Allow UV light anytime system function, there is a double redundant UV light window interlock relay. To override the UV light window interlock relay, the relay itself must also be shorted. (See electrical schematic for reference).



Manual Blower Restart –

Normally when the blower is actively running and a power interruption occurs. The blower will automatically come back on when power is restored. If this function is turned off, the blower will not automatically come back after a power interruption, but would require the user to press the blower key to restart the blower.



Nite Care –

Normally the Nite Care function is turned off. If selected and turned on, once the blower is actively running. Upon closure, the blower will continue to run at a calibrated lower speed level to keep the work zone interior sterile. The PresurFlow™ will indicate(s) blinking green LEDs along with green LED above blower key. The fluorescent light will turn off (blue LED above light key will blink if window closure turned it off) and become inoperable; however the UV light can be used.



Disable PresurFlow™ -

If this function is active, the digital pressure sensor and alarm function are turned off.



Temporary Nite Care -

When this option parameter is turned on and the other requirements below are met, the blower key (when held for 5 seconds) will toggle blower between normal and Nite Care blower speed. The Nite Care blower will time out, based on the Auto Timer duration for Nite Care without a blower key press and the blower speed will revert back to normal. Closing the window will automatically terminate.

In addition to turning this option on the following requirements must also be met

- The Nite Care must be selected
- Password must be selected
- Window is at normal height and blower is running
- Nite Care blower auto timer must be set for a minimum of 15 minutes.



Disable audible alarms / audible key feedback

Normally audible alarms from the PresurFlow™ monitor and audible key feedback are present to provide an audible sound to the user. If this function is active, all audible sound will be silenced when the control system is in normal run mode. Audible sound will still occur in any service/calibration menu function.

11.0 Remote Contacts

The NU-620 has several contact closures for remote sensing of various functions.

11.1 Fan Relay

The fan relay contacts are normally open and closed contact closure outputs that are activated whenever the blower key is pressed and the blower key LED indicator is on or blinking. Contact ratings are 250 VAC maximum at 2 Amps.

11.2 Alarm Relay

The alarm relay contacts are normally open and closed contact closure outputs which are activated whenever an airflow alarm condition occurs. Contact ratings are 250 VAC maximum at 2 Amps.

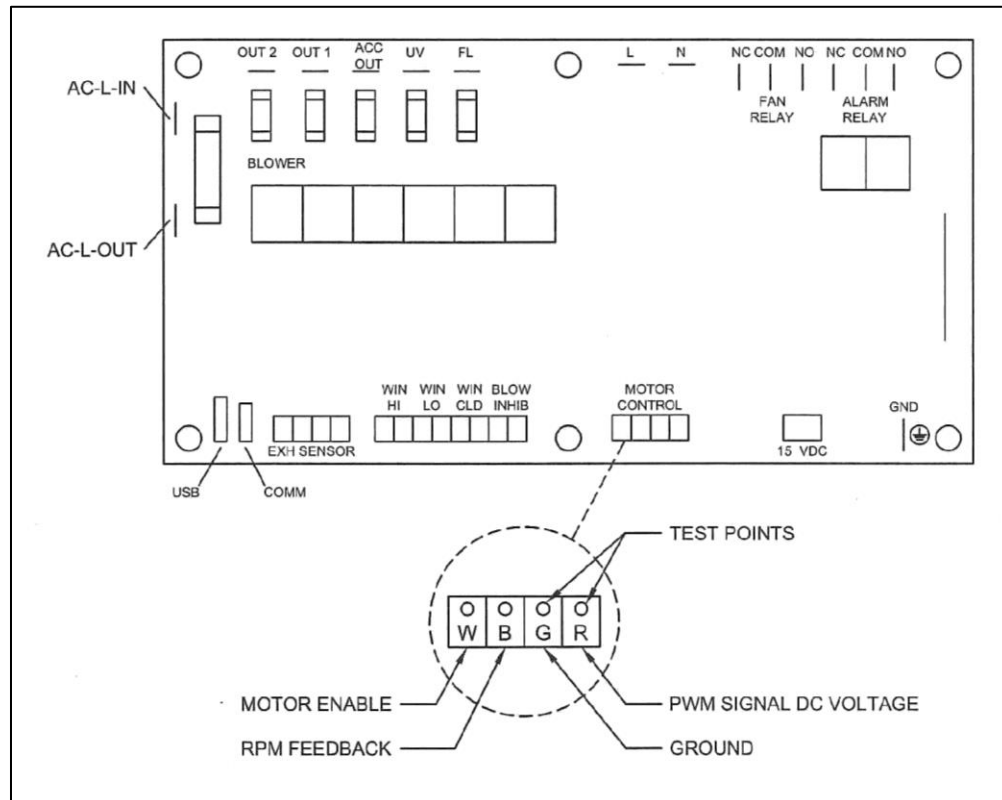

11.3 15VDC Output

The 15VDC (100mA) output is generated if the blower is actively running.

12.0 Electrical/Environmental Requirements

12.1 Electrical: (Supply voltage fluctuations not to exceed +/-10%)

<u>Electrical</u>	<u>Voltage</u>	<u>Frequency</u>	<u>Phase</u>	<u>Current (Amps)</u>
NU-620/621-300	115	60 Hz	1	12
NU-620/621-400	115	60 Hz	1	12
NU-620/621-500	115	60 Hz	1	12

12.2 Operational Performance - Indoor Use Only

Environment Temperature Range: 60°F - 90°F (15.6°C - 32.2°C)
Environment Humidity: Maximum relative humidity 80% for temperatures up to 31°C decreasing linearly to 50% relative humidity at 40°C
Environment Altitude: 6562 Feet (2000 Meters) Maximum

12.3 Light Exposure

Standard LED Lighting @ 150 ft. candles (1614 LUX) maximum intensity.

12.4 Installation Category: II

Installation category (overvoltage category) defines the level of transient overvoltage which the instrument is designed to withstand safely. It depends on the nature of the electricity supply and its overvoltage protection means. For example, in CAT II, which is the category used for instruments in installations supplied from a supply comparable to public means, such as hospital and research laboratories and most industrial laboratories, the expected transient overvoltage is 2500 V for a 230 V supply and 1500 V for a 120 V supply.

12.5 Pollution Degree: 2.0

Pollution degree describes the amount of conductive pollution present in the operating environment. Pollution degree 2 assumes that normally only non-conductive pollution such as dust occurs with the exception of occasional conductivity caused by condensation.

12.6 Chemical Exposure

Chemical exposure should be limited to antibacterial materials used for cleaning and disinfecting. **CHLORINATED AND HALOGEN MATERIALS ARE NOT RECOMMENDED FOR USE ON STAINLESS STEEL SURFACES.** Chamber decontamination can be accomplished by paraformaldehyde, vapor phased Hydrogen Peroxide or Ethylene Oxide without degradation of cabinet materials.

12.7 EMC Performance (classified for light industrial)

Emission: EN61326
Immunity: EN61326



Class A equipment is intended for use in an industrial environment. In the documentation for the user, a statement shall be included drawing attention to the fact that there may be potential difficulties in ensuring electromagnetic compatibility in other environments, due to conducted as well as radiated disturbances.

13.0 Disposal and Recycle

Cabinets that are no longer in use and are ready for disposal contain reusable materials. ALL components with the exception of the HEPA filters may be disposed and/or recycled after they are known to be properly disinfected.

NOTE: Follow all local, state and federal guidelines for disposal of HEPA filter solid waste.



BIOHAZARD

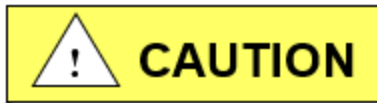

Prior to any disassembly for disposal, the cabinet must be decontaminated.



Recycle

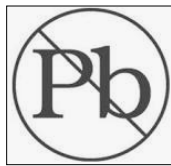

Lead Free

<u>Component</u>	<u>Material</u>
Main Cabinet	Painted Steel
Plenum	Stainless Steel
Worksurface	Stainless Steel
View Screen	Polycarbonate
Window Frame	HDPE
Supply Diffuser	Aluminum
Exhaust Diffuser	Aluminum
HEPA Filter Frames	Painted Steel
Motor	Various Steel / Copper
Printed Wiring Assembly	Lead Free Electronic
Wire	PVC Coated Copper
Ballasts	Various Steel, Electronic
Connectors	Nylon
Hardware	Stainless Steel and Steel

Note: Material type can be verified with use of a magnet with stainless and aluminum being non-magnetic.

14.0 Preventive Maintenance Checklist

Prefilters – Check Daily

- Check supply prefilter
 - Check exhaust mesh prefilter
 - Check exhaust prefilter
- * Clean (black washable foam) or replace (white disposable) if necessary

Worksurface – Yearly\As Needed

- Clean the work surface top
 - Clean under the work surface
 - Check for rubber feet on worksurface and prop rods
- * Replace if missing
- Check tightness of acorn nuts on prop rod supports
- * Tighten and replace if necessary

Windows – Yearly\As Needed

- Check acorn nuts holding window hinge
 - Check window clips and make sure they hold the window up
- * Tighten and replace if necessary
- Clean the View Screen Window, both sides

Diffuser Screen – Yearly\As Needed

- Check thumbscrews
- * Tighten and replace if necessary

Other – Yearly\As Needed

- Check lift system rod/base assembly attachment
- Appendix A of STB0214 (Preventive Maintenance Check List)
- Check castors
- * Tighten if necessary
- Check cord reel and cord for signs of wear
- * Replace if necessary
- Check thumbscrews holding feed hopper (Optional)
 - Check tightness of push\pull bars
 - Run the autolift up and down to ensure proper function
 - Check that the LED light bulbs are working correctly
 - Check all the switches and indicators for correct operation

REV	CO	DESCRIPTION	DATE	DFTR	CHKD
G	002584	UPDATED IMPELLER	11/2/2023	LS	MSS

ITEM	QTY	DESCRIPTION	UN/ARE	PIN
1	1	POWER CORD REEL 15 AMP	F-620-2397	
2	3	FUSE (1 AMP) (5 X 20mm) (LIGHTS)	X-669038-13	
3	1	FUSE 10 AMP (1/4 X 1-1/4) (BLOWER)	X-669052-01	
4	1	FUSE 2 AMPS (LIFT)	X-669311-08	
5	1	FUSE 3 AMPS (6X20mm) (OUTLET)	X-669039-03	
6	1	LAMPHOLDER FIXED BASE	X-669163-02	
7	1	10K POT	X-669514-02	
8	2	FUSE HOLDER	X-669318-01	
9	2	GAF III (BASIC)	BSC-000542	
10	1	FUSE 5 AMPS	F-620-2416	
11	1	HYDRAULIC LIFT (115V)	X-669094-17	
12	0-2	LED LAMP 58" (4 & 5 FT)	569-00014-02	
13	0-2	LED LAMP 24" (3 FT)	569-00014-01	
14	1	FUSE 5 AMPS	X-669311-01	
15	1	IMPELLER (3 & 4 FT.)	X-669148-17	
16	1	DUPLEX OUTLET GFI	X-669830	
17	1	DUPLEX COVER GFI	X-669031-01	
18	1	OUTLET	X-669611	
19	1	OUTLET COVER	X-669031-02	
20	24	JUMPER TERMINAL BLOCK	X-669030-01	
21	2	TERMINAL BLOCK ASSY CONTAINING: * END, NO PLACE, TERMINAL BLOCK * END, 4 PLACE, TERMINAL BLOCK * TERMINAL BLOCK 2 PLACE NON-END * TERMINAL BLOCK 4 PLACE NON-END	A-425-4089-02	
22	3	WIRE NUT 2 POSITION LEVER	X-669834-01	
23	2	9 PIN CONNECTOR PLUG	X-669235-02	
24	2	9 PIN CONNECTOR RECEPTACLE	X-669234-02	
25	1	BULKHEAD CONNECTOR 6 PIN	A-425-3654-03	
26	1	EMI FILTER	X-669319-03	
27	2	3 PIN CONNECTOR RECEPTACLE	X-669235	
28	26	3 PIN CONTACT	X-669244-01	
29	2	3 PIN CONNECTOR PLUG	X-669237	
30	26	SOCKET CONTACT	X-669244-02	
31	1	CONNECTOR HOUSING	X-669048-03	
32	1	CONNECTOR SOCKET	X-669692-03	
33	0-1	BLOWER ASSY 3 FT	F-620-2303	
34	0-1	BLOWER ASSY 4 & 5 FT	F-620-2422	
35	1	2 PIN CONNECTOR RECEPTACLE	X-669238	
36	1	2 PIN CONNECTOR PLUG	X-669239	
37	1	IMPELLER 5 FT.	AF-000272	

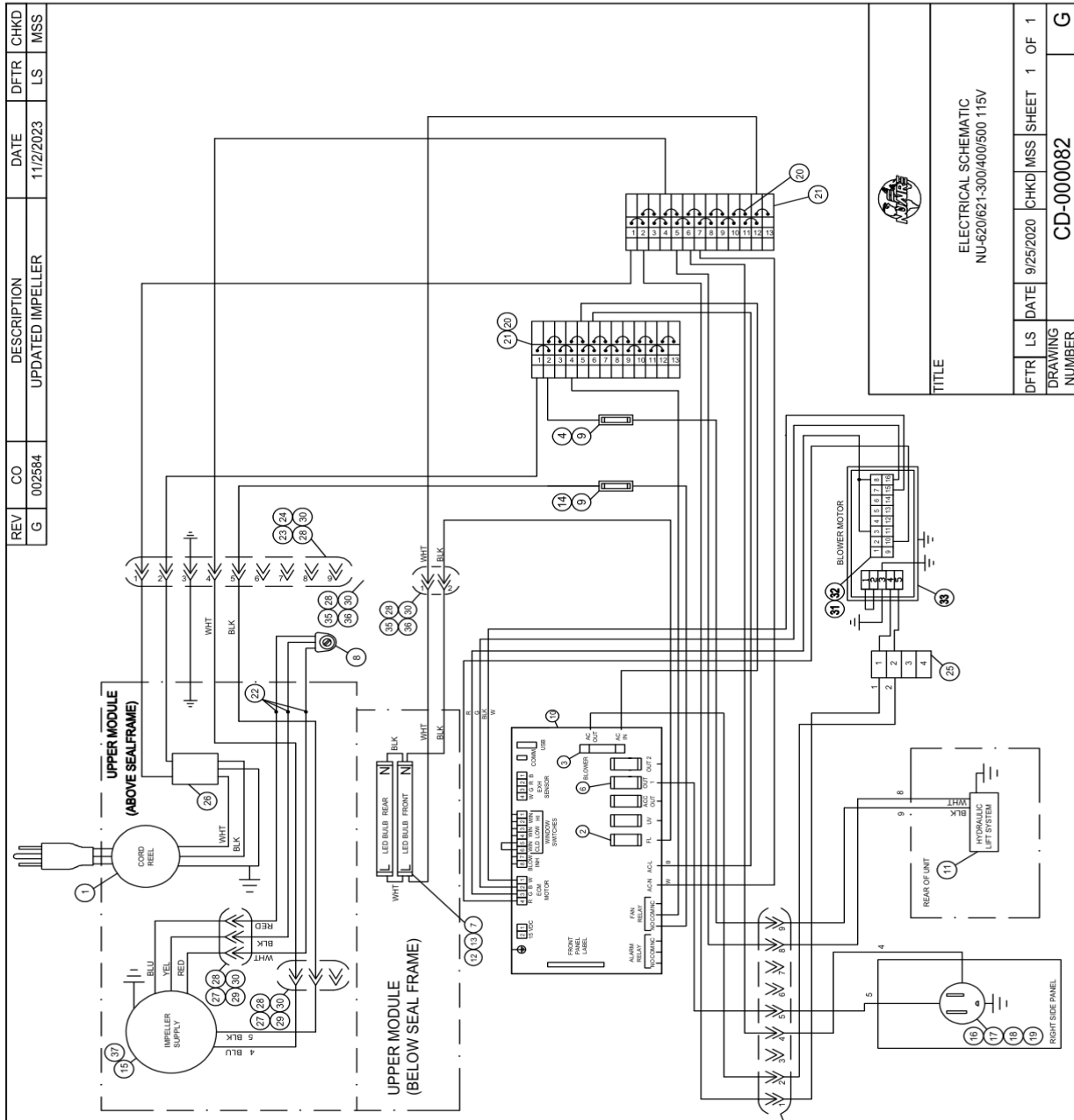

TITLE				ELECTRICAL SCHEMATIC NU-620/621-300/400/500 115V	
DFTR	LS	DATE	CHKD	MSS	SHEET 1 OF 1
DRAWING NUMBER			CD-000082		
					G