

**Allergard Class I  
Animal Bedding Disposal Cabinet**

**Models:  
NU-608-400E**

**Operation and Maintenance Manual**

**November, 2022  
Revision 2**



**Manufactured By:**  
NuAire, Inc.  
2100 Fernbrook Lane  
Plymouth, MN 55447  
Toll-Free: 1-800-328-3352  
In Minnesota: (763)-553-1270  
Fax: (763)-553-0459

**Allergard Class I  
Animal Bedding Disposal Cabinet  
Models  
NU-608-400E  
Operation and Maintenance Manual**

**Table of Contents**

Section No. 1.....General Description  
Section No. 2.....Models and Features  
Section No. 3.....Warranty  
Section No. 4.....Shipments  
Section No. 5.....Installation Instructions  
    5.1.....Location  
    5.2.....Set-Up Instructions  
    5.3.....Electrical Services  
    5.4.....Certification Testing Methods and Equipment  
Section No. 6.....Operating the NU-608  
    6.1.....Aeromax Control System  
    6.2.....Operating Guidelines  
    6.3.....Bag Installation and Removal  
    6.4.....Ergonomics  
    6.5.....Cleaning Procedures  
Section No. 7.....General Maintenance  
    7.1.....Decontamination  
    7.2.....LED Lamp Replacement  
    7.3.....Filter Replacement  
    7.4.....Motor/Blower Replacement  
    7.5.....Airflow Calibration  
    7.6.....Filter Integrity Check  
Section No. 8 .....Error Messages, Troubleshooting and Option-Diagnostics  
Section No. 9.....Remote Contacts  
Section No. 10.....Polycarbonate Material Compatibility  
Section No. 11.....Electrical/Environmental Requirements  
Section No. 12.....Disposal and Recycle  
Insert.....Replacement Parts List

**Standard Drawings**

CD-000107.....NU-608 Airflow Schematic  
CD-000105.....NU-608 Spec. Drawing W/Telescoping Base  
CD-000109.....NU-608 Spec. Drawing W/Motorized Base  
BCD-16521.....NU-608 Control Panel  
CD-000110.....NU-608 Final Assembly Drawing  
CD-000108.....NU-608 Electrical Schematic (230VAC)

# **Allergard Class I Animal Bedding Disposal Cabinet**

Models:

NU-608-400E

Operation and Maintenance Manual

**MANUFACTURED BY:**

NuAire, Inc. - Plymouth, Minnesota

## **1.0 General Description**

### **1.1 Description**

The Allergard™ Model NU-608 Class I Animal Bedding Disposal Cabinet is a product resulting from the latest design innovations, highest quality and newest product features that the Animal Research Professional demands. The NU-608, with the spacious 14-inch (356mm) work access opening, provides personnel protection for handling low to moderate risk material, minimizing the risk of exposure to allergens and animal infections for the laboratory staff. Because a Class I cabinet allows room air to flow over the work surface, the cabinet does not provide a sterile environment for cage cleaning activity. Refuse disposal bag access is also provided within the work zone area maintaining containment during the bag installation and removal process.

The NU-608 meets the requirements of a Class I, since the cabinet conforms to the following requirements:

1. Maintains a minimum inflow velocity of 100 LFPM (.51mps) through the work access opening.
2. Discharges air to the outside atmosphere after HEPA filtration.

## 1.2 Safety Instructions

These safety instructions describe the safety features of the Allergard™ Model NU-608.

The safety cabinet has been manufactured using the latest technological developments and has been thoroughly tested before delivery. **However, the cabinet may present potential hazards if it is not installed and used as instructed for its intended purpose or is used outside of operating parameters.** Therefore, the following procedures must always be observed:

- The safety cabinet must be operated only by trained and authorized personnel.
- For any operation of this cabinet, the operator must prepare clear and concise written instructions for operating and cleaning, utilizing applicable safety data sheets, plant hygiene guidelines, and technical regulations, in particular.
  - which decontamination measures are to be applied for the cabinet and accessories
  - which protective measures apply while specific agents are used
  - which measures are to be taken in the case of an accident
- Repairs to the device must be carried out only by trained and authorized expert personnel.
- Keep these operating instructions close to the cabinet so that safety instructions and important information are always accessible.
- Should you encounter problems that are not detailed adequately in the operating instructions, please contact your NuAire Representative of NuAire technical Services.

## 1.3 Explanation of Symbols



Safety alert symbol indicates a potentially hazardous situation which, if not avoided, could result in death or serious injury.

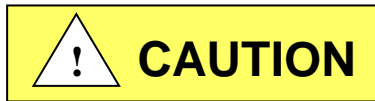

Safety alert symbol indicates a potentially hazardous situation which, if not avoided, may result in minor or moderate injury.

CAUTION

CAUTION used without the safety alert symbol indicates a potentially hazardous situation which, if not avoided, may result in property damage.



Potential electrical hazard, only qualified person to access.



NOTE:

Used for important information.



Biohazard



Flammable Hazard



Ground, Earth



Lead Free



Hazardous Gases! Personal Protection Equipment Required.



Chemical Hazard

## 2.0 Models & Features

The NU-608 is manufactured in one size. 4 ft. (1.2m)

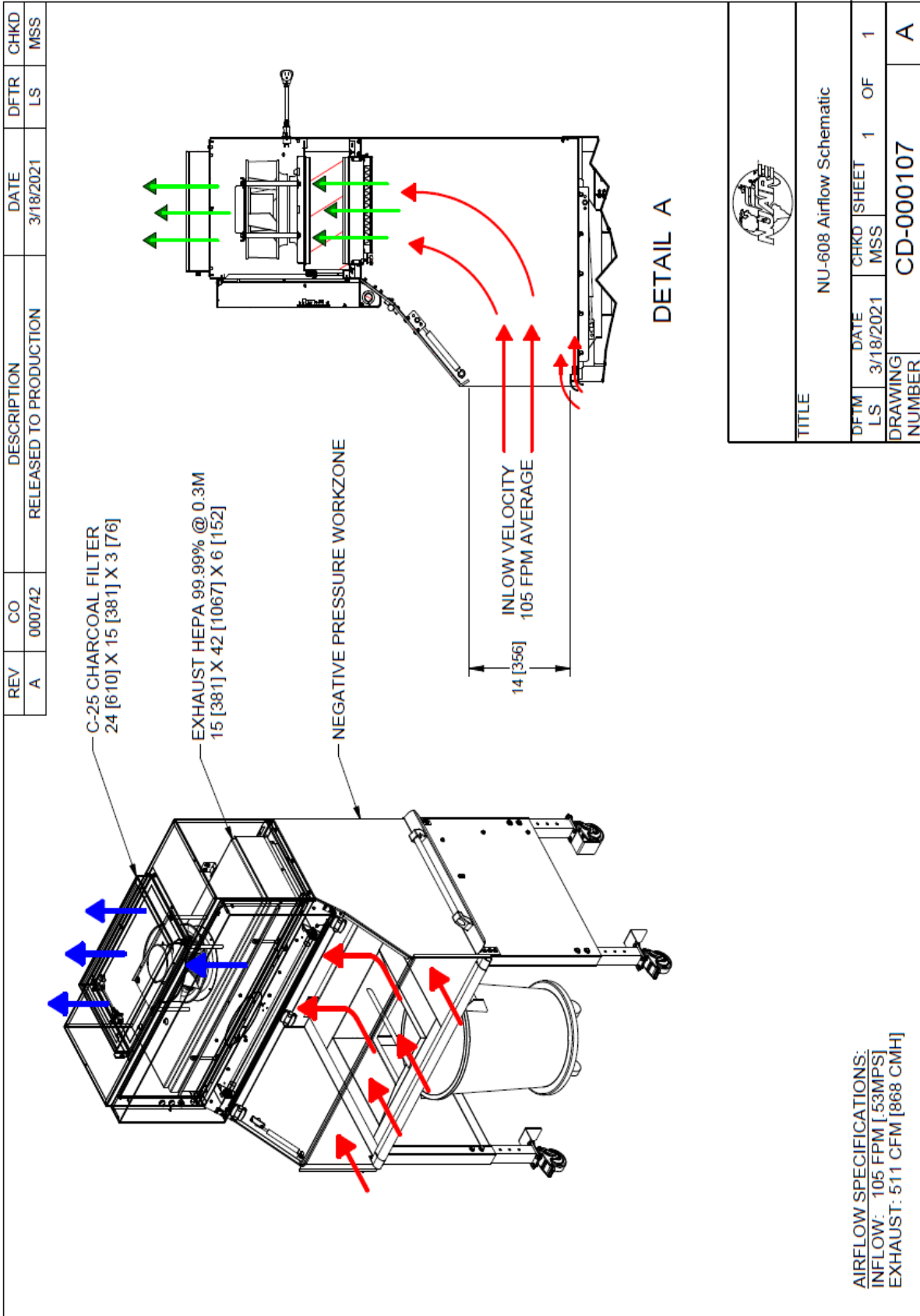

REV	CO	DESCRIPTION	DATE	DFTR	CHKD
A	000742	RELEASED TO PRODUCTION	3/18/2021	LS	MSS

					
TITLE					
NU-608 Airflow Schematic					
DFTR	DATE	CHKD	SHEET	1	OF
LS	3/18/2021	MSS	1	1	1
DRAWING NUMBER			CD-000107		
					A

REV	CO	DESCRIPTION	DATE	DFTR	CHKD
A	000742	RELEASED TO PRODUCTION	3/18/2021	LS	MSS

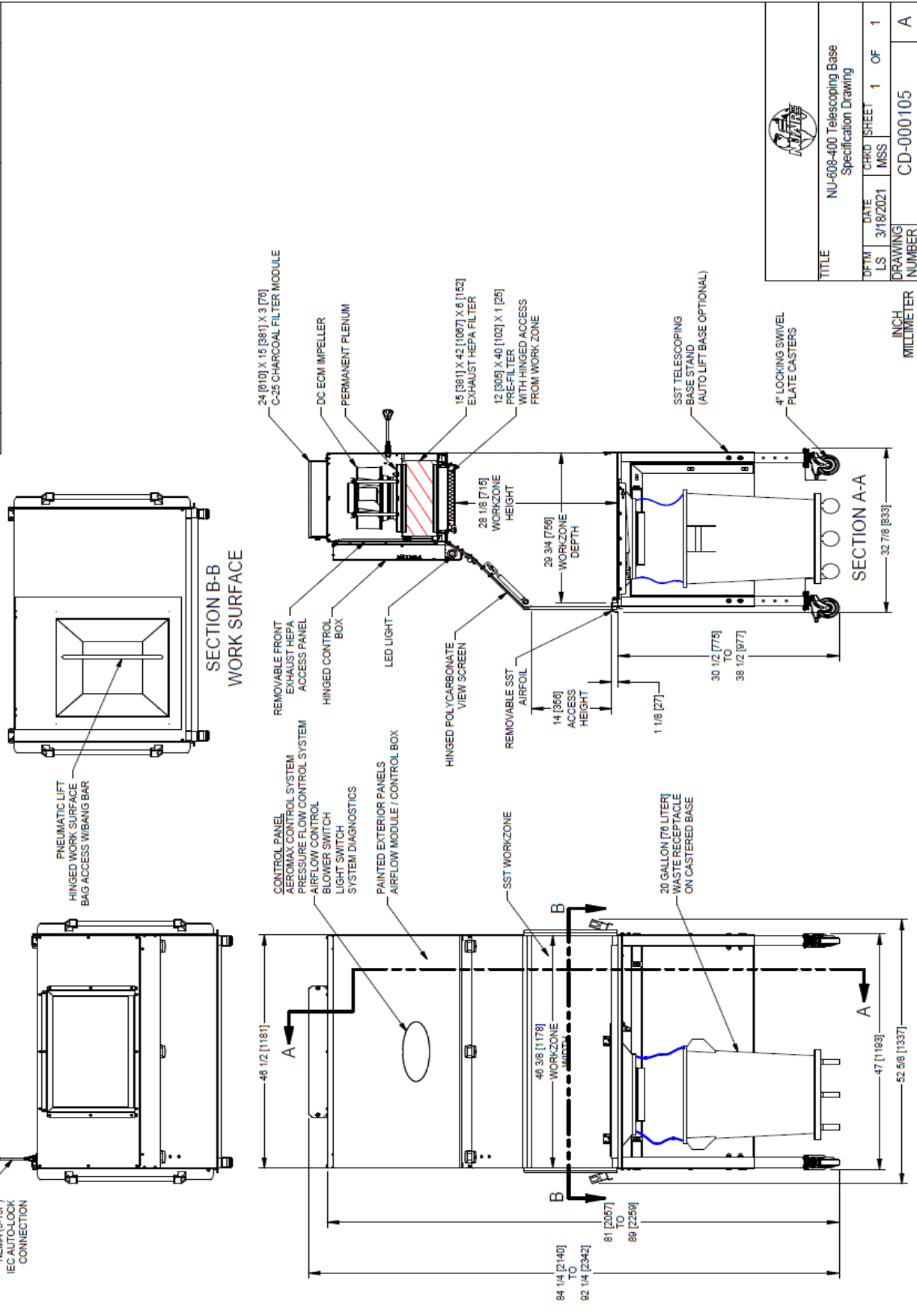

TITLE NU-608-400 Telescoping Base Specification Drawing	
DATE 3/18/2021	CHKO SHEET 1 OF 1
DFTR LS	MSS
DRAWING NUMBER	CD-000105
INCH MILLIMETER	

REV	CO	DESCRIPTION	DATE	DFTR	CHKD
A	000742	RELEASED TO PRODUCTION	3/18/2021	LS	MSS

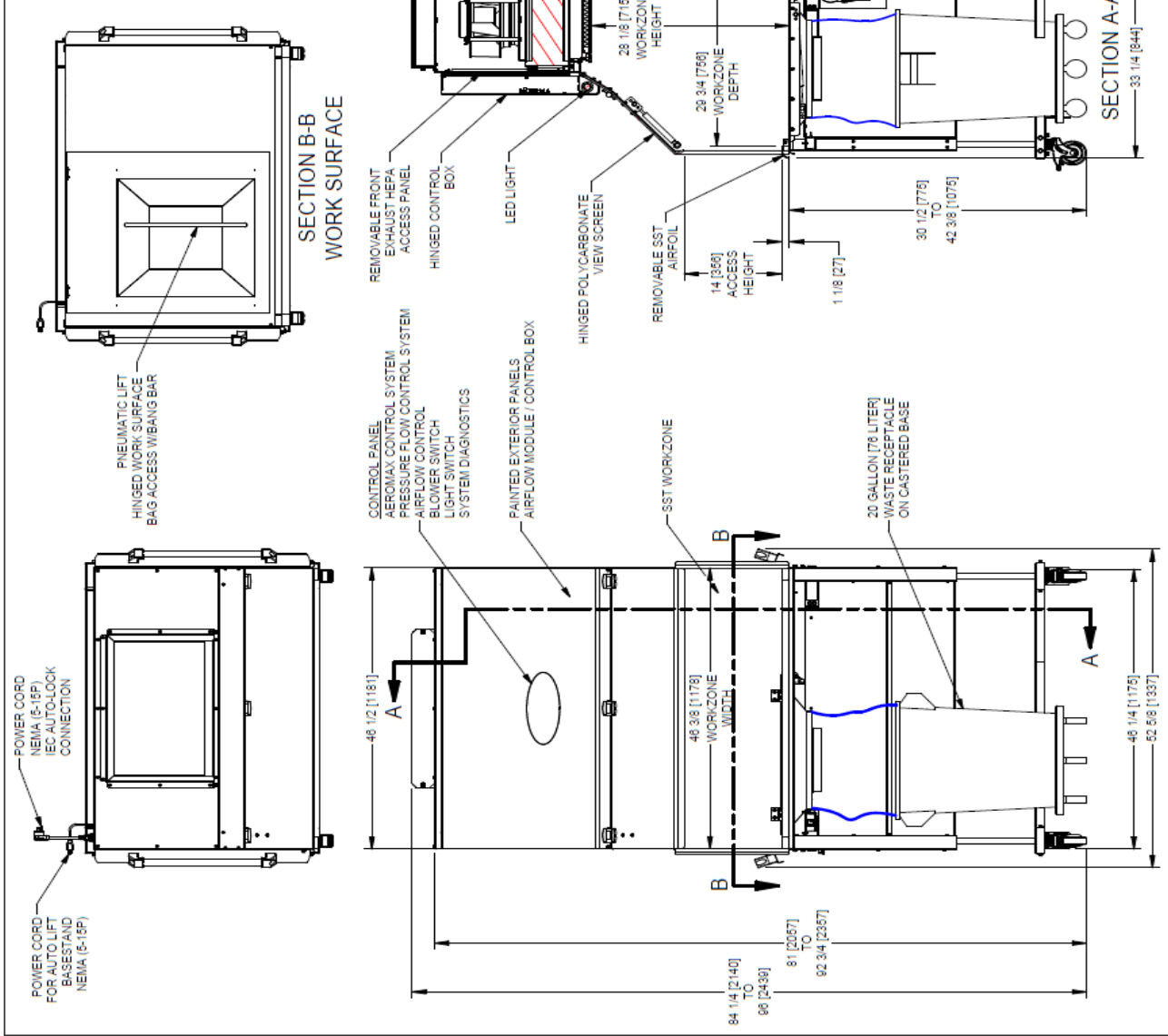

TITLE		NU-608-400 Auto Lift Base Specification Drawing	
DATE	3/18/2021	CHRD	MSS
DFTR	LS	SHEET	1 OF 1
DRAWING NUMBER		CD-000109	
INCH		MILLIMETER	
		A	



## 3.0 Warranty

Details regarding product warranties can be found in the published warranty data separate from this manual and included within the data packet sent with the unit.

## 4.0 Shipments

NuAire takes every reasonable precaution to assure that your Allergard cabinet arrives without damage. Motor carriers are carefully selected and shipping cartons have been specially designed to insure your purchase. However, damage can occur in any shipment and the following outlines the steps you should take on receipt of a NuAire Allergard cabinet to be sure that if damage has occurred, the proper claims and actions are taken immediately.

### 4.1 Damaged Shipments

- 4.1.1** Terms are factory, unless stated otherwise. Therefore, it is important to check each shipment before acceptance.
- 4.1.2** If there is visible damage, the material can be accepted after the driver makes a notation on the consignee's copy of the freight bill. Then an inspection must be made to verify the claim against the carrier. This inspection is the basis of your filing the claim against the carrier.
- 4.1.3** If concealed damage is found, it is absolutely necessary to NOTIFY THE FREIGHT AGENT AT ONCE, and request an inspection. Without this inspection, the transportation company may not accept a claim for loss or damage. If the carrier will not perform the inspection, an affidavit must be prepared stating that he was contacted on a certain date and that he failed to comply with the request. This, along with other papers in the customer's possession, will support the claim.

## 5.0 Installation Instructions

### 5.1 Location

Within the laboratory, workspace, etc., the ideal location of the NU-608 is away from personnel traffic lanes, air vents (in or out), doors and/or any other source of disruptive air currents.

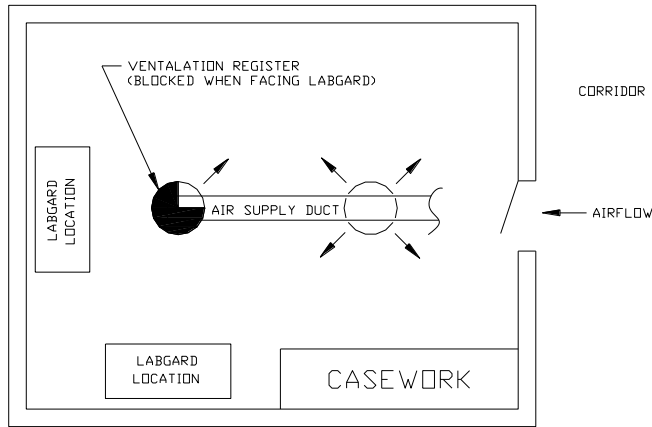

### SUGGESTED CABINET LOCATION IN LABORATORY

If drafts or other disruptive air currents exceed the intake velocity of the cabinet through the access opening, the potential exists for contaminated air to exit the cabinet. It depends on the severity of the air current. Remember, a containment hood is not a substitute for good laboratory technique.

For proper cabinet ventilation, the rear of the NU-608 should be placed no closer than 6 inches (152mm) from the wall or any object that would impede the exhaust air. The airflow monitor will, however, alert the operator if insufficient air is being exhausted (or work access inflow velocity).

### 5.2 Set-Up Instructions

Step 1: Remove from pallet and install casters and safety angles.

Step 2: The charcoal filter is protected from sorption during shipment by a plastic covering, which must be removed before the unit will function properly (see Section 7.3 for filter removal).

### 5.3 Electrical Services

The NU-608 is provided with a detachable power cord. The station requires 230 VAC, single phase power and is recommended to be on its own branch circuit, protected with a 15 Amp circuit breaker at the distribution panel.



Only use Power Cord provided or one with same ratings.

#### **5.4 Certification Testing Methods and Equipment**

After installation and prior to use, NuAire recommends that the cabinet be certified or commissioned to factory standards. At a minimum, the following test should be performed.

1. HEPA filter leak test
2. Airflow velocity
3. Airflow smoke patterns

Of these tests, in order to ensure that no disruptive air currents are penetrating the air inflow barrier smoke flow tests must be performed. These tests must result in the containment of smoke passed around the perimeter of the work access opening. A smoke source shall be passed along the entire perimeter of the work opening edges, approximately 1.5 inches (38mm) outside the cabinet. The smoke shall show a smooth inward flow with no escape from the work access opening.

**IT IS RECOMMENDED THAT THESE TESTS BE PERFORMED BY A QUALIFIED TECHNICIAN WHO IS FAMILIAR WITH THE METHODS AND PROCEDURES FOR CERTIFYING SAFETY CABINETS.**

**AFTER THE INITIAL CERTIFICATION, NUAIRE RECOMMENDS THAT THE CABINET BE RECERTIFIED AT A MINIMUM ON AN ANNUAL BASIS AND AFTER EVERY FILTER CHANGE OR MAINTENANCE ACTION OR ANY TIME THE OPERATOR FEELS IT IS NECESSARY.**

Note that NuAire cabinets, filters and seals provide premium performance; Quality Control in both design and manufacturing assure superior reliability. However, protection to the operator is so vital that certification to the performance requirements should be accomplished as stated to ensure safety established by the factory standards.

Catalog Number	Model
	NU-608-400E Nominal 4 foot (1.2m)
Performance Specifications 1. Personal Protection	NSF/ANSI 49
NSF Std. No. 49 Class	Class I
Style of Cabinet	Console with integral base
Cabinet Construction	Stainless steel work zone panels and base with painted steel top blower module.
HEPA Filter Seal Type: Exhaust Filter-99.99% Eff. on 0.3 microns	Neoprene, Spring loaded
Fumigation per NIH/NSF Procedure	Yes
Cabinet Size Inches (mm): Height Depth Width	84-1/4 to 92-1/4 (2140 to 2342) 32-7/8 (833) 52-5/8 (1337)
Work Access Opening Inches (mm): Standard Opening Height/Optional Standard Inflow Velocity	14 (356) 105 FPM (0.53 m/s)
Work Zone Inches (mm): Height Depth Width	28-1/8 (715) 29-3/4 (756) 46-3/8 (1178)
Viewing window is ¼ in (6mm). clear polycarbonate	Closed: 14 (356) Open: 28 (711)
CFM @ 105 FPM	511 CFM (868 CMH)
Heat Rejected, BTU, Per Hour (non-vented)	1020
Electrical: Volts, AC 60 Hz Amps: Blower+ Amps: Lights Rated Amps: 10 ft. Power Cord (one)	UL/UL-C Listed 230 1.2 .1 5 14 GA - 3 Wire, 15A
Crated Shipping Weight: *** Net Weight	450 lbs. / 204 kg. 400 lbs. / 181 kg.

+ Based on cabinet with new filters running at 230VAC

\*\*\*Crated shipping weight does not include weight for accessories or options.

## 6.0 Operating the NU-608

### 6.1 Aeromax™ Control System

#### 6.1.1 Overview

The Aeromax™ control system is designed to service the control requirements of the Allergard NU-608. The Aeromax™ control system consists of an electronic module that will perform the following functions:

- Easy user interface via LED's and function keys
- Control blower via solid state switch.
- Control lights via solid state switch.
- Disable audible alarm switch with ring back function.
- Control blower DC EC Impeller with solid-state DC Motor Controller that provides automatic compensation for line voltage variances.
- Monitor and display airflow system performance via PresurFlow™ monitor.

The Allergard™ NU-608 offers the latest digital microprocessor design technology for improved 608 performance and safety. The Aeromax™ control system integrates a digital pressure sensor (PresurFlow™) to monitor the NU-608 airflow performance. The Aeromax™ control system also integrates a EC Impeller controller that provides automatic compensation for both filter loading and line voltage variances. There is additional on/off control of blower and light. Lastly the Aeromax™ control system monitors the hinged window position with a micro switch. All the above functions are shown in a system block diagram (see figure 1).

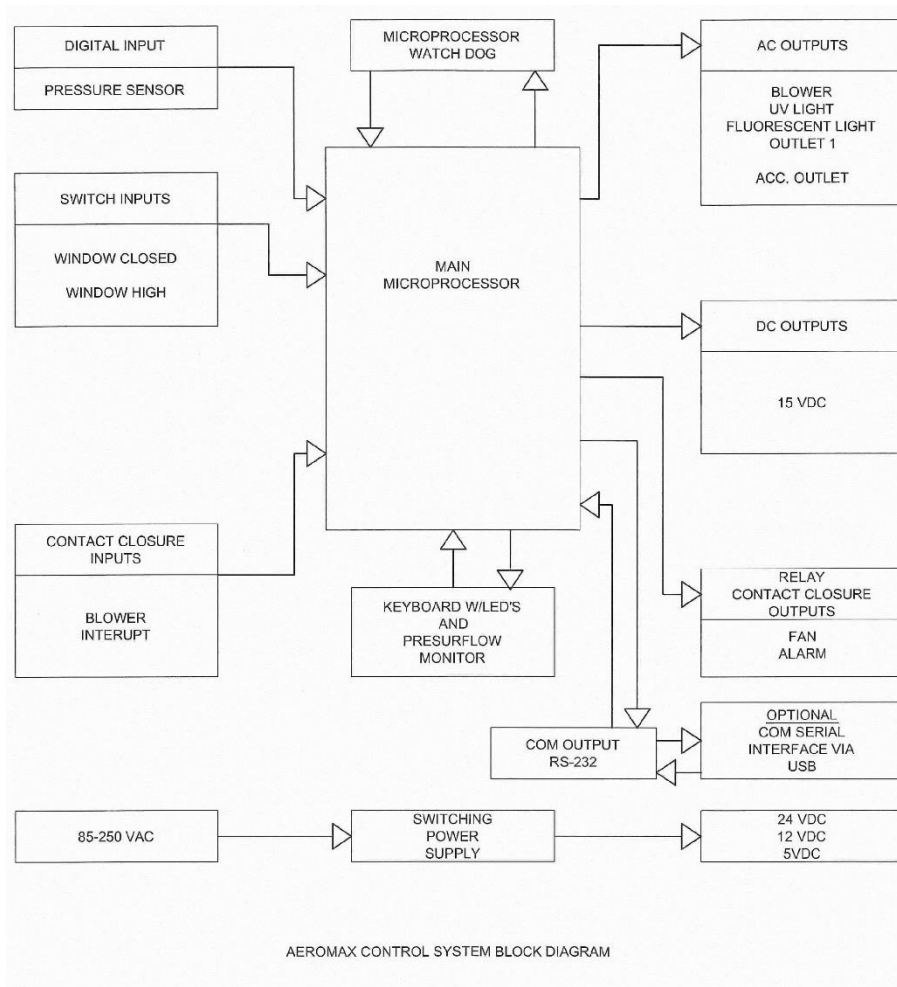
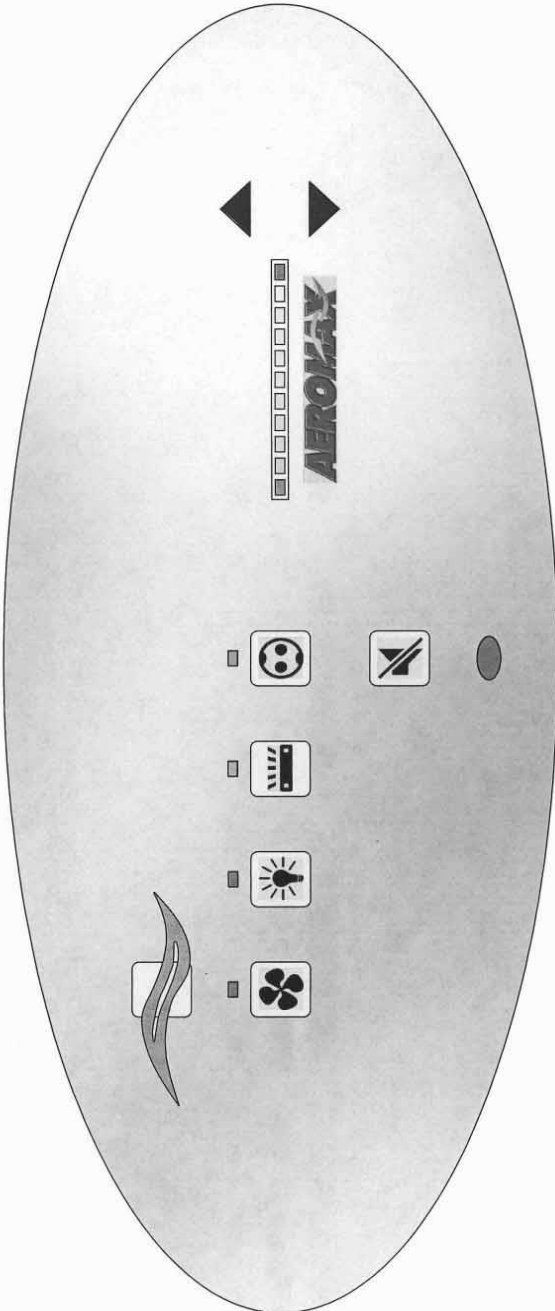

Figure 1

REV	ECO	DESCRIPTION	DATE	DFTM	CHKD
C	13471	UPDATED TITLE	8/25/2017	TH	BP



		ORIGINAL	
TITLE AEROMAX FRONT PANEL			
DFTM	DATE	CHKD	SHEET
LS	12/16/2013	BP	1 OF 1
DRAWING NUMBER		BCD-16521	
			C

## **6.1.2 Front Panel**

The control system front panel contains the following functions described in detail (see Drawing BCD-16521).

### **6.1.2.1 Blower Keys**

The blower key controls the ON/OFF power to the blower.  
LED above key indicates: full green for blower on,  
blinking green for blower pending and  
full red for blower alarm.

### **6.1.2.2 Hidden Key**

The hidden key is located just above the blower LED indicator centered in the airflow symbol. The hidden key is used for various functions including the blower password 3 key sequence if the option is activated.

### **6.1.2.3 Light Key**

The light key controls the on/off power to the light.  
LED above the key indicates full blue for light on.

### **6.1.2.4 Ultraviolet (UV) Light Key (NOT USED)**

### **6.1.2.5 Outlet Keys (NOT USED)**

### **6.1.2.6 Red Alarm LED**

The red alarm LED will indicate any alarm condition and remain indicating until the alarm condition is cleared.

### **6.1.2.7 Audible Alarm Silence**

The audible alarm silence key allows user interaction to silence an audible alarm for a period of 15 minutes. After 15 minutes if the alarm condition still exists, the audible alarm will again sound. The audible alarm silence key also is used to exit all Aeromax™ user interaction menus.

### **6.1.2.8 Arrow Adjustment Keys**

The arrow adjustment keys allow user interaction for various functions.

## **6.1.3 Aeromax™ Control System Power**

After the Allergard NU-608 is plugged into the appropriate facility line power the control system will power up. The control panel will also indicate the power up status by blinking the red alarm LED. Pressing any key will acknowledge the power up status and turn off the blinking red alarm LED.

If a power interruption occurs, all control system functions, calibrations and parameters will be maintained and continue upon restoration of power. Just as the initial power up, the red alarm LED will blink to indicate power up status.

## **6.1.4 Standby Mode**

When the 608 is not in use any of the function keys except the blower that initiates run mode may be turned on and off in standby mode.

### 6.1.5 Run Mode

Any time the blower run key is pressed with the hinged window at its correct operational height, the RUN MODE screen will be initiated. The Run Mode will start with the PresurFlow™ entering and approximate 3 minute warm up period. The PresurFlow™ LED indicators will blink and indicate the following sequence:

- 1<sup>st</sup> minute – Left and right Red LED's will blink
- 2<sup>nd</sup> minute – Left and right Green LED's will blink
- 3<sup>rd</sup> minute – Center 3 Green LED's will blink

Once the warm up period is complete, only one LED will indicate cabinet airflow status.

During the warm up period the cleaning process may begin. If the hinged window is raised, an audible and visual alarm will occur, but may be silenced by pressing the alarm silence key.

### 6.1.6 Standby/Run Mode Alarms

If present, standby/run mode alarms will be both visual and audible, the red alarm LED oval will turn on. Audible alarms will produce an alarm tone for 30 seconds, then ring back for 2 seconds of every 5 seconds. Pressing the alarm silence key will silence the audible alarm for 15 minutes initially then will start the ring back function again.

The list below represents alarm types and their respective priority from the highest to lowest priority.

- 1) New Firmware Loaded
- 2) Internal Board Failure
- 3) Power on Reset
- 4) Airflow Pressure Alarm
- 5) Blower RPM Failure
- 6) Window Open



 **Note:** The above messages are described in greater detail in section 8.





## 6.1.7 Operator Accessible Functions

### 6.1.7.1 Access and Navigation





To access the operator accessible functions,

- Press and hold the  key, then enter the 3 key sequence for the desired function, then release the  key and follow each instruction set.

 **Note:** Pressing the  key at any time will abort and exit the process without saving any changes. Pressing the hidden key will accept all changes and exit.

### 6.1.7.2 Auto Timer Duration

Auto timer duration timers are countdown timers for the functions displayed once time is entered into a function. The timer will begin to countdown upon the start of that function (i.e. press UV light key to start timing the UV light). The LED indicator above the function key will start to blink indicating the timer function. If the LED indicator was full on, no timer function is present. As the timer expires the function will turn off.

- Select auto timer duration function
  - Outlets  
Press and hold  key, then press hidden – outlet – outlet keys sequentially. LED indicator above outlet will blink fast. Adjust desired time as described below.
  - Lights  
Press and hold  key, then press hidden – light – light keys sequentially. LED indicator above light will blink fast. Adjust desired time as described below.
  - UV Light  
Press and Hold  key, then press hidden – UV light – UV light keys sequentially. LED indicator above UV light will blink fast. Adjust desired time as described below.
- Low Flow Blower
  - Press and hold  key, then press hidden-blower-blower keys sequentially. LED indicator above Blower key will blink fast. Adjust desired time as described below.
    - Adjust countdown time  
Press  $\uparrow$  or  $\downarrow$  keys to adjust time.  
Time will change in 15 minute increments as shown on the PresurFlow™ LED segments below.



- Press hidden key to accept time and exit.
- Press  key at any time to abort and exit.

### 6.1.7.3

#### Blower Password

The blower on/off password allows the cabinet user to place a 3 key sequence requirement to turn the blower on or off.

The 3 key sequence for the blower password will be a combination of the hidden and blower keys.

- Select blower password

Press and hold  key, then press hidden – blower – hidden keys sequentially.  
Red LED indicator above blower will blink fast.

- Select password

Press  $\uparrow$  or  $\downarrow$  key to scroll through the code choices below,

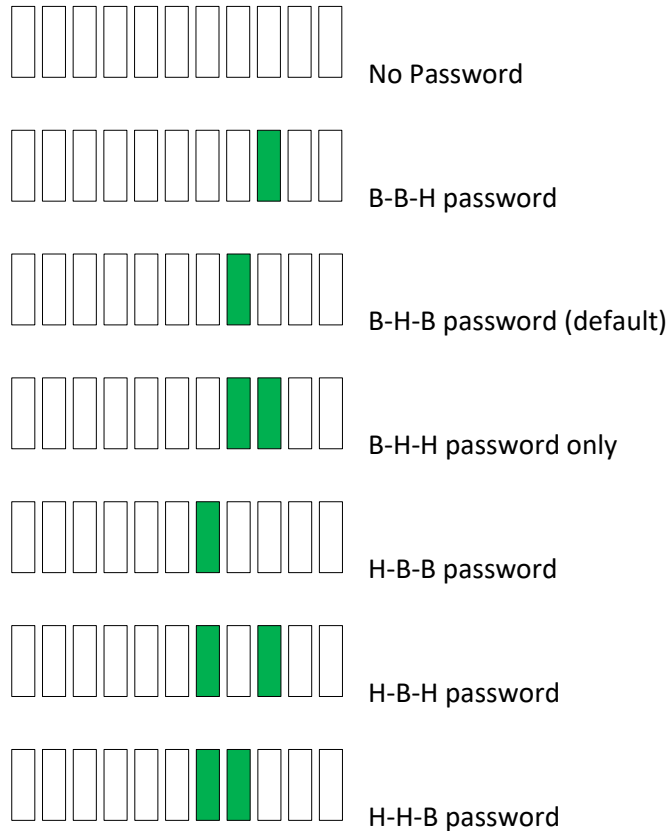

- Press hidden key to accept time and exit.
- Press  key at any time to abort and exit.



**Note:** If the required blower password option is selected in the blower airflow option menu (see section 8.2.2). Then the “No password” choice above is not available and the default remains B-H-B.

## 6.2 Operating Guidelines

- 6.2.1** The intent herein is to present general operating guidelines that will aid in the use of the 608 to control airborne contaminants of low to moderate risk.
- 6.2.2** Procedure protocols defined in terms of the barrier of control concepts unique to the 608 must be developed in order to obtain a maximum potential for safety and protection. The pre-planning necessary to develop these protocols is based on several fundamental considerations, each of which will contribute to optimum benefits from the equipment:
- Minimize disruption of "air curtain"
  - Minimize room activity
  - Employ aseptic techniques
- 6.2.3** The minimum number of items necessary should be placed into the enclosure to prevent overloading, but the work should also be planned to minimize the number of times an operator's hands and arms must enter and leave the air curtain at the open face. The ideal situation is to have everything needed for the complete procedure placed in the enclosure's workzone before starting, so that nothing need pass in or out through the air barrier at the face until the procedure is completed. This is especially important in working with moderate risk agents.



**Note:** When working with agents of lower risk, it is not as important for all materials to be placed in the enclosure workzone before starting, or for the procedure to be completely finished before materials are removed. Also, the time period for a unit of work may be continued over a more extended period during which entries and withdrawals from the enclosure may be made.

### 6.2.4 Minimize Room Activity

Activity in the room itself should be held to a minimum. Unnecessary activity may create disruptive air currents as well as interfere with the work of the operator. A person walking past the front of 608 can cause draft velocities up to 175 fpm (.88 m/s), which are sufficient to disrupt the air barrier provided by the work access opening.

### 6.2.5 Employ Methodical Technique

The operator must not assume an attitude of "let the 608 do it". Properly used, the 608 will do an excellent job of containing viable or toxic agents. Normal laboratory contamination control procedures and basic methodical techniques are necessary to obtain maximum benefit from the 608. This precaution is merely an extension of good laboratory technique as practiced on open bench tops. The good laboratory practices designed to minimize creating and/or release of aerosols to the environment should not be discontinued.

In brief, the consideration which should be made in order to obtain optimal personnel safety and product protection may be reiterated:

- Pre-plan the procedures carefully
- Minimize disruption of the "air curtain"
- Employ aseptic techniques

### 6.2.6 Operating Sequence

Start Up - Turn on 608 blower and lights, check air intake and exhaust portals of the unit to make sure they are unobstructed. Blower speed must only be readjusted by qualified maintenance technicians.

Allow blowers to operate for a minimum of 5 minutes before manipulations are begun in the NU-608. If the filtered air exhausted from the unit is discharged into the room, as in some installations, an additional advantage is obtained from purification (filtration) of characteristic contributing to the quality of the laboratory environment, some owners of NU-608 leave them in operation beyond the time of actual use.

### 6.2.7 Wipe down for 608 Operation

The interior surfaces of the work space, if desired should be disinfected by wiping them thoroughly with 70 percent alcohol or similar non-corrosive antimicrobial agent.

 **NOTE: DISINFECTANTS THAT USE CHLORIDES AND HALOGENS WILL CAUSE DAMAGE TO THE STAINLESS STEEL SURFACES IF PRESENT AND LEFT ON FOR LONG PERIODS OF TIME. IF THE DISINFECTANT USED CONTAINS CHLORIDES OR HALOGENS, RE-WIPE ALL SURFACES WITH 70% ALCOHOL OR SIMILAR NON-CORROSIVE ANTI-MICROBIAL AGENT TO PREVENT DAMAGE TO STAINLESS STEEL.**

### 6.2.8 Materials & Equipment

As with any routine task whether it's in a vivarium or a manufacturing facility, the process set up is very important not only for efficiency of the task, but also safety. The apparatus and materials should next be placed into the enclosure workzone. Materials should be arranged so that clean and dirty (used) materials are well separated. In this case, the supply of dirty cages should be close to the cabinet, so cages are easily reachable as well as the depositing of cages to whatever material handling device is used.

### 6.2.9 Perform work

The work can now be performed. The technician performing the work is encouraged to wear appropriate personal protective equipment (PPE), (i.e. a long-sleeved gown with knit cuffs, rubber gloves and appropriate respirator). This will protect the hands and arms from viable agent and chemical contamination. At a minimum, the hands and arms should be washed well with germicidal soap before and after work. The cage dump process both the inward motion into the cage dump cabinet as well as the removal from the cage dump cabinet should be consistent. It doesn't need to be slow, just methodical and gaged, not hurried. The cage should always open side up and goes in/out perpendicular to the front of the cabinet. The actual cage dump itself should be done completely inside the work area. The work zone would be defined as starting behind the front lip of the work surface.

### 6.3.10 Terminal Purging & Wipe down

Following completion of the work, allow the cabinet to run for a 2-3 minute period without personnel activity to purge the unit. The decontamination of the interior surfaces should be repeated after removal of all materials, culture, apparatus, etc. A careful check should be made for spilled or splashed which may contaminate the work environment.

### 6.2.11 Shut Down

Turn off blowers and lights. Do not use 608 as a depository for excess laboratory equipment during period of non-operation.

### 6.3 Bag Installation and Removal

The bag is accessed by lifting up the chute assembly, which is aided by a pneumatic lift. Once open, the bag can be removed (pulled up) from the ring holder, gathered and tied off. For replacement, the bag should come up through and over the ring (overlapping the ring by at least 3 inches (75mm)) and then place the ring with bag overlapping back down on the chute, so the overlapping bag is held in place by the weight of the ring.

### 6.4 Ergonomics

Ergonomics, the study or accommodation of work practices is extremely important for proper 608 usage and user health and safety. An evaluation of normal work practices should be performed with each user when working in a 608. Evaluation criteria should be at a minimum:

- a. Proper user posture
- b. Effective workzone layout for work practice
- c. Vision or sightlines

### 6.5 Cleaning Procedures

#### 6.5.1 General

Cleaning laboratory equipment is important in terms of both functionality and general good housekeeping. The information provided below is intended to aid the development of facility Standard Operating Procedures (SOP's) for cleaning the equipment. It is strongly recommended that all cleaning materials used be tested and verified both in terms of both effectiveness and material compatibility before they are written into the cleaning SOP documentation.

a. The airflow blower should be operating during the cleaning process to maintain sterility and/or containment during the cleaning process.

b. Raise window to gain additional access if desired.

c. Apply appropriate cleaning material or surface disinfectant to surfaces. Most surface disinfectants require a specific contact time depending the materials used within the work zone. **CONSULT APPROPRIATE DISINFECTANT DOCUMENTATION FOR PROPER APPLICATION AND SAFETY PRECAUTIONS.**

c-1. Polycarbonate (Covestro® Makrolon®AR) has noted material compatibility concerns (see polycarbonate compatibility section). They recommend the use of Hydrogen Peroxide based materials such as the following:

- Steriplex SD
- Safetec surface wipes
- Peridox RTU

It is recommended to AVOID the use of cleaning materials that contain Chlorine, Quaternary Ammoniums and Phenol's.

If the polycarbonate is lightly scratched, it may be able to be polished out with Mirror Glaze Plastic Polish or similar.

Further information may be available from [www.covestro.com](http://www.covestro.com)

c-2. Stainless steel (type 304) has noted material compatibility concerns with Acids, Chlorides and Halogens. **IF THESE MATERIALS ARE USED AND ALLOWED TO BE LEFT ON THE STAINLESS STEEL SURFACE, OXIDATION AND DEGRADATION WILL OCCUR.** Only by re-wiping surfaces with either sterile water or 70% IPA will remove harmful materials from the stainless steel surface.

Further information is available at the following: [http://www.parrinst.com/wp-content/uploads/downloads/2011/07/Parr\\_Stainless-Steels-Corrosion-Info.pdf](http://www.parrinst.com/wp-content/uploads/downloads/2011/07/Parr_Stainless-Steels-Corrosion-Info.pdf)

NOTE: NuAire does not offer any product warranty with respect to cleaning material compatibility. **USE AT YOUR OWN RISK!** The information provided above is from raw material suppliers and known general source documents for use to develop application cleaning SOP's.

## 7.0 General Maintenance



ATTENTION ACCOMPANY'S  
INFORMATION OR IMPORTANT  
SYMBOL



POTENTIAL ELECTRICAL  
HAZARD ONLY QUALIFIED  
PERSON TO ACCESS

**CAUTION: A qualified technician who is familiar with the proper maintenance procedures required for this equipment, as well as repair must perform all maintenance actions on this equipment.**

### 7.1 Decontamination

No maintenance should be performed on the interior of the Allergard cabinet (area behind access panels) unless the cabinet has been microbiologically decontaminated, is known to be biologically clean, or know to be chemically inert.

If microbiological decontamination is necessary, use the following procedure:

1. Place decontamination equipment inside the work area. Reference decontamination procedure (per NSF Standard 49, Annex G or En 12469:2000, Annex J), using the following chart to calculate chemical requirements.

Model	NU-608-400E
Cabinet Dimensions	52.675 x 32.875 x 84.25 in. To 52.675 x 32.875 x 82.25 in.  (1337 x 833 x 2140 mm) To (1337 x 833 x 2342 mm)
Blower cabinet dimensions	22 x 46.5 x 17 in. (.56 x 1.2 x .43m)
Total cabinet volume	76.cu.ft. (2.15cu.m)

2. Seal entire unit to floor using plastic and tape.  
Allow access to cabinet power cord to operate fan during decontamination procedure.

**CAUTION: BE SURE CABINET IS TOTALLY SEALED TO PREVENT ANY  
LABORATORY EXPOSURE TO DECONTAMINATION GAS.**

3. Perform decontamination procedure per NSF Standard 49, Annex G or En 12469:2000, Annex J.

### 7.2 LED Lamp Replacement

The LED lamp is cool white placed external to the cabinet to aid maintenance. The life rating of the lamp is 50,000 hours. The lamp is removed by displacing to one side against the compressible lamp holder.

### 7.3 Filter Replacement

- 7.3.1** The HEPA filters under normal usage and barring an accident do not need replacement until the work access inflow velocity cannot be maintained (see Section 7.5). Sorbent filters need to be replaced when they no longer contain odors.

**7.3.2** When installing new filters, **use only filters of the same rated flow and size as originally installed.**

Description:	Exhaust HEPA Filter
Efficiency:	99.99% @ 0.3 Micron
Airflow Rating:	100 fpm @ .29 ± .05" w.g. per sq. ft.
Frame Type:	Metal

NU-608-400

NuAire Part Number:	A-980939-14
Filter Size:	15" (381mm) x 42" (1067mm) x 6" (152mm)
Filter Manufacturer:	Camfil Farr

**7.3.3** To install the HEPA filter grease the bottom gasket of the filter lightly with silicone grease and carefully insert. Position the filter frame within the outside walls of the exhaust opening on the top of the hood.

**7.3.4** Prefilters should be cleaned or replaced every 3 months or whenever necessary, dependent upon excessive particulate loading.

**7.4 Motor/Blower Replacement**

The motor/blower assembly should never need any preventative maintenance. But in case of a malfunction, the following steps should be taken. Disconnect power or unplug unit before working with any electrical wiring. Motor/blower removal should be done by a qualified technician (see reference drawing CD-000110).

**7.5 Airflow Calibration**

The NU-608 Airflow Calibration consists of adjusting the airflow within the cabinet. **THIS WORK SHOULD BE DONE ONLY BY A QUALIFIED TECHNICIAN WHO CAN MEASURE THE AIRFLOW FROM THE FILTERS WITH A SUITABLE VELOMETER.** NuAire provides one adjustment to set the airflow within the cabinet. This is:

Blower speed adjustment via motor voltage regulator.

The blower speed control system adjusts the cabinet's total volume of airflow as well as makes up for filter resistance tolerances.

The cabinet is considered to be certifiable if the following airflow measurements are present:

Inflow average: 105 LFPM ±5 LFPM (.53 m/s ±0.25 m/s) using the direct inflow measurement method or related value using the calculated inflow velocity measurement method.

**BEFORE STARTING AIRFLOW CALIBRATION PROCEDURE, LET THE CABINET RUN FOR AT LEAST 10 MINUTES.**

**7.5.1 Inflow Calibration**

Step 1: Measure the inflow velocity using the recommended procedure found in Table 7.0. If necessary, adjust to achieve the correct average inflow velocity within the stated range of 105 ±5 LFPM (.53 ±0.25 m/s).

Step 2: If necessary, adjust airflow control potentiometer, located under the removable cap plug on front panel, too the above stated airflow requirements.



## 7.6 Filter Integrity Check

The filter must be scan tested before installation into the HEPA clean airflow module. Once installed, an internal reference leak test can be performed to assure a proper installation was performed. Challenge aerosol (One Laskin Nozzle, PAO) can be introduced through the center of the front access panel of the cabinet and the port (3/8" NPT Coupling) for measuring downstream leaks is located on the front of the cabinet in the upper right hand corner. The filter integrity can be calculated by using the internal reference light on the photometer using 511 CFM for airflow volume.

Internal reference concentration with one Laskin Nozzle open should be:

$$C_{PAO} = 13,500 \left( \frac{1}{511 \text{ CFM}} \right) = 26.4 \mu\text{g/l}$$

The gain setting for a concentration of 26.4  $\mu\text{g/l}$  is:

$$\frac{100 \mu\text{g/l}}{26 \mu\text{g/l}} \times 10\% = 38\%$$

**Table 7.0**  
**Recommended Measurement Methods for Cabinet Inflow**

### a. Inflow Measurement

The inflow velocity is measured by using a Direct Inflow Measurement (DIM) Instrument (i.e. Shortridge flowhood). The DIM Instrument can be used directly on the cabinet with NO CORRECTION FACTORS REQUIRED. The DIM Instrument should be equipped with a flowhood that is as close as possible to the width of the cabinet (i.e. NU-608-400E should use 1 x 4 foot flowhood). The DIM Instrument should also be duct taped to the cabinet to prevent any sneak air paths from occurring.

The DIM Instrument will read inflow volume (i.e. CFM). Use the window access opening area to calculate inflow velocity.

The calculated inflow measurement method may also be used. Inflow air velocity is measured on a 3.916 inch by 3.916-inch (100mm by 100mm) grid in a vertical plane defined by the access opening. Readings are taken 4 inches (102mm) from the top and bottom of the opening and 4 inches (102mm) from the sides.

Test Data - Inches (mm):

DIM Measurement:

Measured Intake Volume	ft. <sup>3</sup> /min. (m <sup>3</sup> /s)
Access Open Area	4.51 ft. <sup>2</sup> (.42m <sup>2</sup> )
Inflow Velocity	ft./min.(m/s)

Inflow Velocity Measurement - Inches (mm):

### Front Access Opening

Top	4	7.916	11.83	15.74	19.66	23.58	27.49	31.41	35.32	39.25
Left	(102)	(201)	2	8	4	0	6	2	8	0
			(301)	(400)	(500)	(599)	(698)	(798)	(897)	(997)
4										
(102)										
10										
(254)										

Number of Readings	Average Velocity	ft./min.(m/s)
--------------------	------------------	---------------

## **8.0 Error Messages, Troubleshooting, Option-Diagnostics and Airflow Sensor Performance Verification**

Audible alarms and error messages occur for a variety of reasons. Whenever an alarm condition has been present for a period of at least 10 seconds, the audible alarm/error message will be presented and stay on until the error is cleared. The audible alarm will be on for 30 seconds upon initial alarm condition, then once every ten seconds. When presented with an error message, please perform the following:

Step 1: NOTE ALL ERROR MESSAGES.

Error message will appear on the control panel with red LED's.

Step 2: VERIFY ERROR MESSAGES.

Error messages can be verified by clearing the error function by either turning the blower or the cabinet on and off.

Step 3: MONITOR RE-OCCURRENCE OF ERROR MESSAGES.

If re-occurrence of the error message is immediate or daily, use the following guide to correct the situation.

## 8.1 Error Message Troubleshooting Guide

Error Message	Error Description	Correction
Cabinet LED lights won't Turn on	Blue LED above light key indicates the lamp should be on.	Check light fuse on main control board. Check LED lamps. Check voltage coming out of main control board to light ballasts. Check light starters, if present. Check ballast.
Cabinet blower won't turn on.	Green LED above blower key indicates the blower should be on. Airflow Alarm.	Check blower fuse on main control board. Check AC voltage coming out of main control board. Check wiring to blower. Check blower motor. Check DC motor PWM signal on main control board.
Red alarm LED blinks	Indicates a power interruption has occurred.	Press any key to clear.
Blower or light fuse continues to blow after replacement.	N/A	Check for short on output of fuse. Isolate output of fuse by disconnecting control center connectors, light circuit, AC or DC blower circuit, etc. to isolate the short.
Blower green LED blinks fast and PresurFlow™ 3 green LED's indicators on	Indicates that the Nite Care is activated, preventing the usage of the cabinet.	N/A
PresurFlow™ left red LED indicator on and red LED alarm	PresurFlow™ reading low flow (pressure)	Check airflow values. Check blower function. Recalibrate PresurFlow™ system.
PresurFlow™ right red LED indicator on and red LED alarm	PresurFlow™ reading high flow (pressure)	Check airflow values. Recalibrate PresurFlow™ system.
All PresurFlow™ LED's blink	Message acknowledges new firmware was loaded into microprocessor	N/A
Blower red LED blinks and red LED alarm	Indicates that the motor rpm signal has been interrupted	Check connectors and wires from main control board to the motor Replace motor if required

## 8.2 Option Parameters

The option parameter menu allows **A QUALIFIED TECHNICIAN** to configure several different optional parameters per the menu as described below.

### 8.2.1 Sync Function with Active Blower

To access the option parameter menu, perform the following:

- Press and hold  key, then press hidden - Blower - Fluorescent keys sequentially. Red LED indicator above the blower key will blink fast

The PresurFlow™ blinking green LED segments will indicate seven optional parameters as shown and described below. The UV Light key (move lefts) and outlet key (move right) allows selection of the option parameter desired.

Once the desired option parameter is indicated, press ↑ or ↓ key to turn on or off. A slow blinking green LED indicator means off and a fast blinking green LED indicator means on. Multiple option changes can be selected.

- Pressing the hidden key will accept all changes and exit
- Pressing the  key will abort the process and exit

 Sync Fan Relay with Active Blower - Normally the fan relay will activate when the blower switch is pressed. Blower can either be actively running or pending. If the fan relay sync is active the blower must be actively running for the relay to change state.

 Sync Accessory Outlet with Active Blower – Normally the accessory outlet is on all the time. If the accessory outlet sync is active, the blower must be actively running for the accessory outlet to turn on.

 Sync Outlet Power with Active Blower – Normally the outlet power is turned on via the outlet key. If the outlet power sync is active, the outlet power will turn on and off with the blower or may be turned on and off independently if the blower is active.

 Sync LED Light with Active Blower – Normally the fluorescent light is turned on via the fluorescent light key. If the LED light sync is active, the LED light will turn on and off with the blower or may be turned on and off independently if the blower is active.

 Sync 15 Volt DC output with active blower normally the 15 Volt DC output located on the control board is on when power is applied to the system. If the 15 Volt DC output sync is active, the blower must be actively running for the 15 Volt DC output to turn on.

## 8.2.2 Blower/Airflow Options

To access the option parameter menu, perform the following:

- Press and hold  key, then press hidden - ↑ and ↓ keys sequentially. Red LED indicator above the blower key will blink fast

The PresurFlow™ blinking green LED segments will indicate seven optional parameters as shown and described below. The UV Light key (moves left) and outlet key (moves right) allows selection of the option parameter desired.

Once the desired option parameter is indicated, press ↑ or ↓ key to turn on or off. A slow blinking green LED indicator means off and a fast blinking green LED indicator means on. Multiple option changes can be selected.

- Pressing the hidden key will accept all changes and exit
- Pressing the  key will abort the process and exit

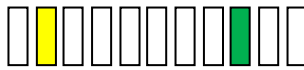

Require Password –

Normally it is not required to use a password (i.e. 3 key press sequence of the blower and hidden key). If the option is turned on, it would be required to use the correct password to turn on the blower. The default password once turned on is blower-hidden-blower keys in sequence. The password can be changed in the blower password option menu.



Allow UV light anytime – **(UV Light option not available)**

Normally the UV light is interlocked with the window being in the closed position. For service purposes only, if the function is active, the UV light may be turned on at any window height.



**Note:** In addition to the Allow UV light anytime system function, there is a double redundant UV light window interlock relay. To override the UV light window interlock relay, the relay itself must also be shorted. (See electrical schematic for reference).



Manual Blower Restart – Normally when the blower is actively running and a power interruption occurs. The blower will automatically come back on when power is restored. If this function is turned off, the blower will not automatically come back after a power interruption, but would require the user to press the blower key to restart the blower.



Nite Care –

Normally the Nite Care function is turned off. If selected and turned on, once the blower is actively running. Upon closure, the blower will continue to run at a calibrated lower speed level to keep the workzone interior sterile. The PresurFlow™ will indicate(s) blinking green LEDs along with green LED above blower key. The fluorescent light will turn off (blue LED above light key will blink if window closure turned it off) and become inoperable; however the UV light can be used.



Disable PresurFlow™ -

If this function is active, the digital pressure sensor and alarm function are turned off.

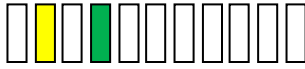

Temporary Nite Care -

When this option parameter is turned on and the other requirements below are met, the blower key (when held for 5 seconds) will toggle blower between normal and Nite Care blower speed. The Nite Care blower will time out, based on the Auto Timer duration for Nite Care without a blower key press and the blower speed will revert back to normal. Closing the window will automatically terminate.

In addition to turning this option on the following requirements must also be met

- The Nite Care must be selected
- Password must be selected
- Window is at normal height and blower is running
- Nite Care blower auto timer must be set for a minimum of 15 minutes.



Disable audible alarms / audible key feedback Normally audible alarms from the PresurFlow™ monitor and audible key feedback are present to provide an audible sound to the user. If this function is active, all audible sound will be silenced when the control system is in normal run mode. Audible sound will still occur in any service/calibration menu function.

## 9.0 Remote Contacts

The NU-540 has several contact closures for remote sensing of various functions.

### 9.1 Fan Relay

The fan relay contacts are normally open and closed contact closure outputs that are activated whenever the blower key is pressed and the blower key LED indicator is on or blinking. Contact ratings are 250 VAC maximum at 2 Amps.

### 9.2 Alarm Relay

The alarm relay contacts are normally open and closed contact closure outputs which are activated whenever an airflow alarm condition occurs. Contact ratings are 250 VAC maximum at 2 Amps.

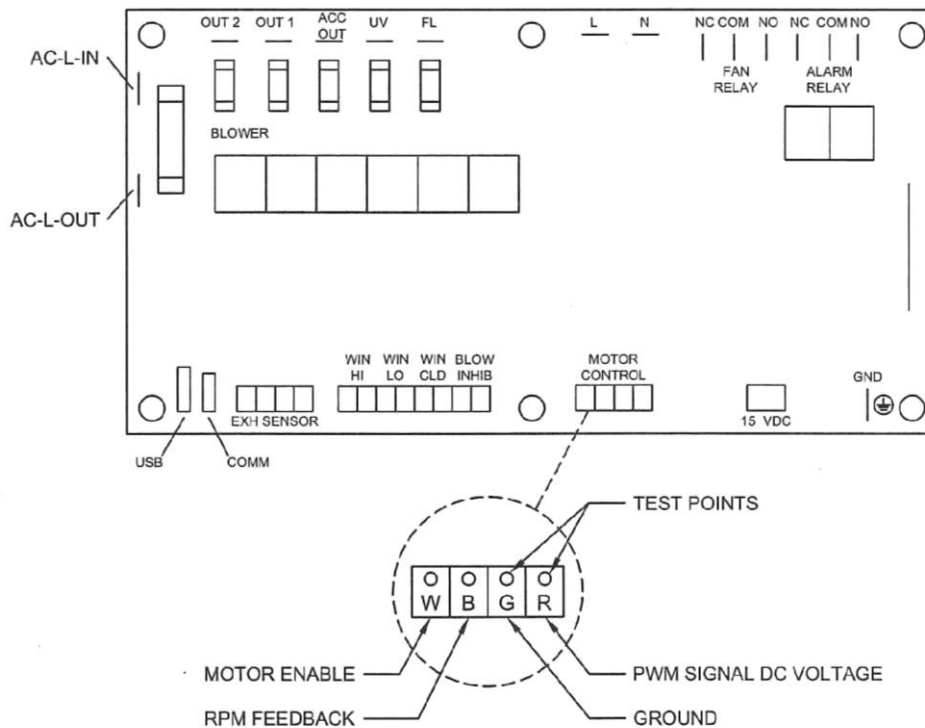

### 9.3 15VDC Output

The 15VDC (100mA) output is generated if the blower is actively running.

- Press and hold  key, then press hidden - ↑ and ↓ keys sequentially. Red LED indicator above the blower key will blink fast

The PresurFlow™ blinking green LED segments will indicate seven optional parameters as shown and described below. The UV Light key (moves left) and outlet key (moves right) allows selection of the option parameter desired.

Once the desired option parameter is indicated, press ↑ or ↓ key to turn on or off. A slow blinking green LED indicator means off and a fast blinking green LED indicator means on. Multiple option changes can be selected.

## 10.0 Polycarbonate Material Compatibility

### 10.1 Polycarbonate sheet is resistant at 70° to these chemicals.

Amyl alcohol	Heptane	Potassium nitrate
Aluminum chloride	Hydrochloric acid (10%)	Potassium perchlorate
Aluminum sulphate	Hydrogen peroxide (30%)	Potassium permanganate
Ammonium chloride	Hydrofluoric acid (10%)	Potassium persulphate
Ammonium nitrate	Isopropyl alcohol (70%)	Potassium sulphate
Ammonium sulphate	Lactic acid (20%)	Silicone oil
Antimony trichloride	Magnesium chloride	Silver nitrate
Arsenic acid	Magnesium sulphate	Sodium bicarbonate
Butyl alcohol	Maganese sulphate	Sodium bisulphate
Calcium nitrate	Mercuric chloride	Sodium carbonate
Chlorinated Lime Paste	Nickel sulphate	Sodium chloride
Chrome alum	Nitric acid (10%)	Sodium hypochlorite
Chromic acid (20%)	Nitric acid (20%)	Sodium sulphate
Citric acid (40%)	Oleic acid	Stannous chloride
Copper chloride	Oxalic acid	Sulfur
Copper sulphate	Pentane	Sulfuric acid (>10%)
Formic acid (10%)	Phosphoric acid (10%)	Sulfuric acid (50%)
Formalin (30%)	Potassium bromate	Tartaric acid (30%)
Glycerine	Potassium bromide	Zinc chloride
		Zinc sulphate

### 10.2 Polycarbonate sheet is not resistant to these chemicals.

Acetaldehyde	Caustic soda solution (5%)	Lacquer thinner
Acetic acid (conc.)	Chloroform	Methyl alcohol
Acetone	Chlorothene	Methylene chloride
Acrylonitrile	Chlorobenzene	Nitrobenzene
Ammonia	Cresol	Nurocellulose lacquer
Ammonium fluoride	Cutting oils	Ozone
Ammonium hydroxide	Cyclo hexanone	Phenol
Ammonium sulfide	Cyclohexene	Phosphorous hydroxy chloride
Benzene	Dimethyl formamide	Phosphorous trichloride
Benzoic acid	Dioxane	Propionic acid
Benzyl alcohol	Ethane tetrachloride	Pyridine
Brake fluid	Ethylamine	Sodium sulfide
Bromobenzene	Ethylene dichloride	Sodium hydroxide
Butylic acid	Ethyl ether	Sodium nitrate
Carbon tetrachloride	Ethylene chlorohydrin	Sulfuric acid (1%)
Carbon disulfide	Formic acid (conc.)	Tetrahydronaphthalene
Carbolic acid	Freon (refrigerant & propellant)	Thiophene
Caustic potash solution (5%)	Gasoline	Toluene
		Turpentine
		Xylene



## 11.0 Electrical/Environmental Requirements

### 11.1 Electrical: (Supply voltage fluctuations not to exceed $\pm 10\%$ )

NU-608-400E	230 VAC,	50/60 Hz,	1 Phase,	5 Amps
Optional integral auto lift base	230 VAC,	50/60 Hz,	1 Phase,	.9 Amps

\*UL Listed or CE Certified

### 11.2 Operational Performance (for indoor use only)

Environment Temperature Range:	60°F - 85°F (15°C - 30°C)
Environment Humidity:	Maximum relative humidity 80% for temperatures up to 31°C decreasing linearly to 50% relative humidity at 40°C
Environment Altitude:	6562 Feet (2000 meters) maximum

### 11.3 Light Exposure

Standard LED Lighting @ 150 ft. candles (1614 LUX) maximum intensity.

### 11.4 Installation Category: 2.0

Installation category (overvoltage category) defines the level of transient overvoltage, which the instrument is designed to withstand safely. It depends on the nature of the electricity supply and its overvoltage protection means. For example, in CAT II, which is the category used for instruments in installations supplied from a supply comparable to public means, such as hospital and research laboratories and most industrial laboratories, the expected transient overvoltage is 2500 V for a 230 V supply and 1500 V for a 120 V supply.

### 11.5 Pollution Degree: 2.0

Pollution degree describes the amount of conductive pollution present in the operating environment. Pollution degree 2 assumes that normally only non-conductive pollution such as dust occurs with the exception of occasional conductivity caused by condensation.

### 11.6 Chemical Exposure

Chemical exposure should be limited to antibacterial surface disinfectants used for cleaning and disinfecting. **USE OF CHLORINATED OR HALOGEN MATERIALS IN THE CABINET MAY DAMAGE STAINLESS STEEL.** Equipment decontamination can be accomplished by non-condensing gas or vapor Paraformaldehyde, Hydrogen Peroxide or Chlorine Oxide following NSF/ANSI 49, Annex I-2 (formerly Annex G).

### 11.7 EMC Performance (classified for light industrial)

Emission:	EN61326
Immunity:	EN61326



**Warning:** Class A equipment is intended for use in an industrial environment. In the documentation for the user, a statement shall be included drawing attention to the fact that there may be potential difficulties in ensuring electromagnetic compatibility in other environments, due to conducted as well as radiated disturbances.

## 12.0 Disposal and Recycle

Cabinets that are no longer in use and are ready for disposal contain reusable materials. ALL components with the exception of the HEPA filters may be disposed and/or recycled after they are known to be properly disinfected.

 **Note:** Follow all local, state and federal guidelines for disposal of HEPA filter solid waste.



BIOHAZARD

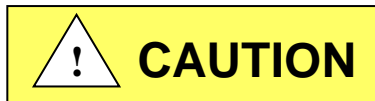

Prior to any disassembly for disposal, the cabinet must be decontaminated.



RECYCLE



LEAD FREE

Component	Material
Top module	Painted Steel
Base Cabinet	Stainless Steel
Worksurface	Stainless Steel
Airfoil	Stainless Steel
Window	Polycarbonate
Front Service Panel	Painted Steel
Front Decorative Panel	Painted Steel
Control Center	Painted Steel
Exhaust Filter	Aluminum
HEPA Filter Frames	Painted Steel
Impeller	Various Steel
Printed Wiring Assembly	Lead Free Electronic
Wire	PVC Coated Copper
Connectors	Nylon
Hardware	Stainless Steel and Steel

 **Note:** Material type can be verified with use of a magnet with stainless and aluminum being non-magnetic.

REV	CO	DESCRIPTION	DATE	DFTR	CHKD
A	000742	RELEASED TO PRODUCTION	3/9/2021	LS	MSS

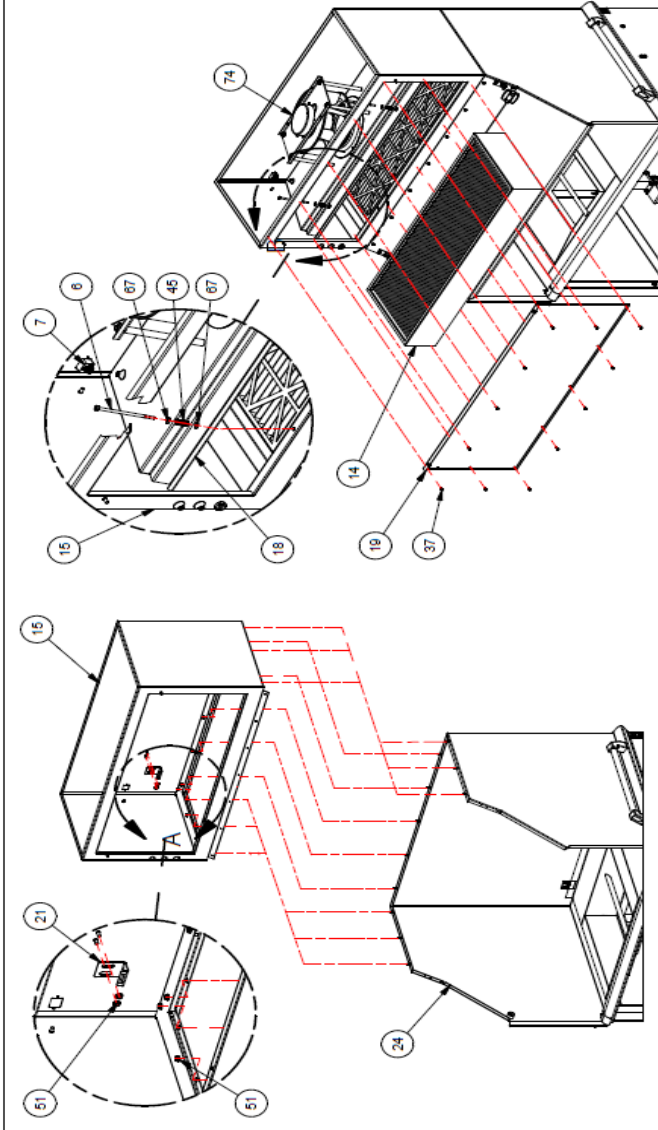

TOP MODULE

PLENUM AND HEPA FILTER

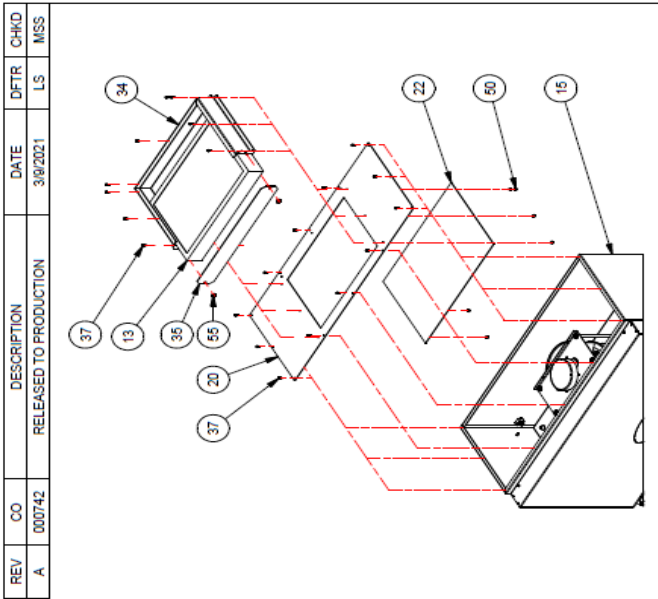

TOP PANEL CHARCOAL FILTER

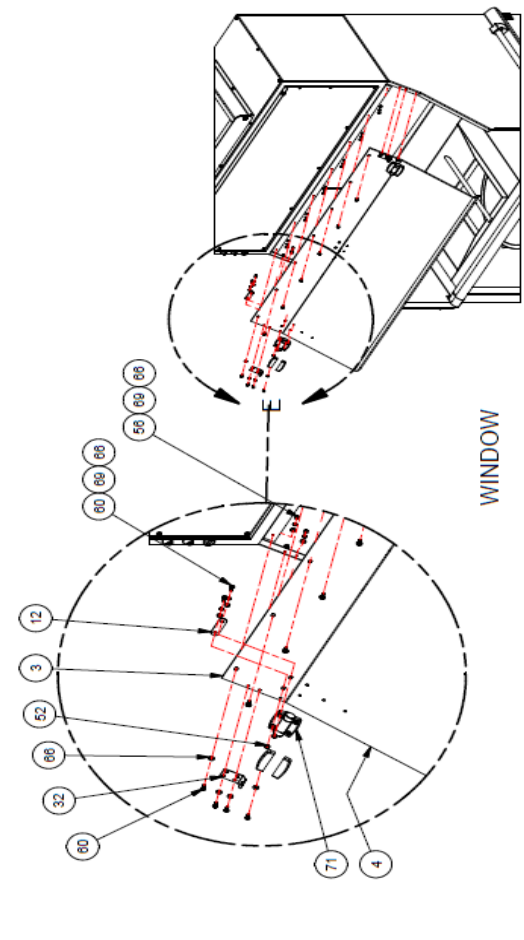

WINDOW

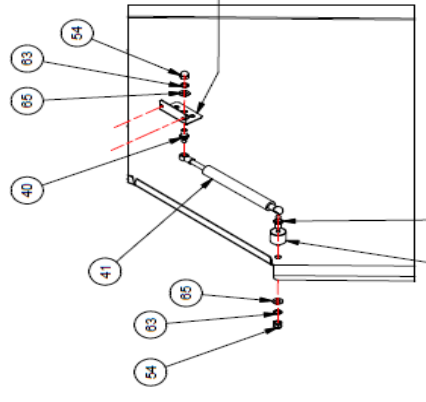

WINDOW GAS SPRING

NU-608 Final Assembly Drawing	
DATE	3/18/2021
LS	MSS
DFTR	LS
CHKD	MSS
DRAWING NUMBER	
CD-000110	
1 OF 2	
A	

ITEM	PART NUMBER	DESCRIPTION	QTY
1	860-000056	Prefilter, 12" X 40" X 1"	1
2	860-000057	Knob, 1/4-20 X 20mm willyard	2
3	860-000058	Panel, 608 Light	1
4	860-000059	Panel, 608 Hinged View Screen	1
5	860-000060	Spacer, 608 View Screen Gas Spring Mount	1
6	860-000061	Bolt, 1/4-20 X 5" SST	2
7	860-000017	Power Cord Connector, IEC C20	1
8	860-000018	Power Cord, NEMA 5-15P, IEC C19 Auto-Lock	1
11	A-813-499	Bracket/Lift	1
12	A-813-1456	Backing Hinge Plate	6
13	A-680289-23	Charcoal Filter C-25 24X15X3	1
14	A-680839-14	15X42X9 Aluminum Frame HEPA Filter Bead Pack 99.995	1
15	AF-000100	Weldment, 608 Blower Module	1
16	AF-000107	Assembly, 608 Lower Blower Plenum	1
17	AF-000110	Assembly, 608 Hinged Prefilter Frame	1
18	AF-000113	Wrap, 608 Impeller Mounting Panel	1
19	AF-000114	Panel, 608 Front Access	1
20	AF-000115	Panel, 608 Top	1
21	AF-000116	Bracket, 608 Filter Clamp	2
22	AF-000117	608 Screen Charcoal Filter	1
23.2	AF-000119	Weldment, 608 Control Box	1
23.8	X-660083-05	LED Lamp (SB) 36"	1
24	AF-000126	Weldment, 608 Workzone	1
25	AF-000134	Weldment, 608 Hinged Waste Chute	1
27	AF-000140	Weldment, 608 Waste Chute Gas Spring Mount	1
28	AF-000142	Assembly, 608 Bag Retainer Frame	1
32	AF-000170	Bracket, 608 Control Box Hinge	2
34	B-813-1491	Filter Frame Top Panel	1
35	B-813-1492	Charcoal Cover Plate	1
36	B-813-1591-02	Work Surface Airfoil 4"	1
37	F-425-3907	Screw with Captive O-Ring Assembly	33
39	X-680121-01	Panel Nut #6-32 (Captive)	2
40	X-680185	Zinc Ballstud 5/16-18 X 10Mm	3
41	X-680250-04	Gas Spring	1
44	X-680250-06	Gas Spring	1
45	X-680287-03	Die Spring 1/2 X 1 Medium Heavy Duty	2
50	X-680430-01	Flange Lock Nut #6-32 Nickel (Serrated)	25
51	X-680430-02	1/4-20 Serrated Flange Zinc Locknut	15
52	X-680449-02	Hex Nut #6-32 SST	12
53	X-680493	Acom Nut 1/4-20 (Low Crown) SST	10
54	X-680494-01	Acom Nut 5/16-18 Nickel	3
55	X-680499	Knurled Nut 1/4-20 Brass Nickel	2
56	X-680510	Acom Nut #6-32 SST	23
58	X-680694-02	Machine Screw PTH #6-32 X 3/4 SST	2
60	X-680724-03	Screw PPH #6-32 X 5/8 SST	27
63	X-680781-06	Lock Washer 5/16 Internal Tooth Zinc	3
65	X-680790-08	Washer 5/16 SAE SST	3
66	X-680794-01	Washer #8 SST	50
67	X-680794-02	Washer 1/4 SST	14
68	X-680815-01	Lock Washer 1/4 Internal Tooth SST	10
69	X-680815-03	Lock Washer #8 Internal Tooth SST	35
71	X-680908-02	Hinge	3
74	X-669148-14	1800CFM 115V/310Mm EC Impeller Motor	1

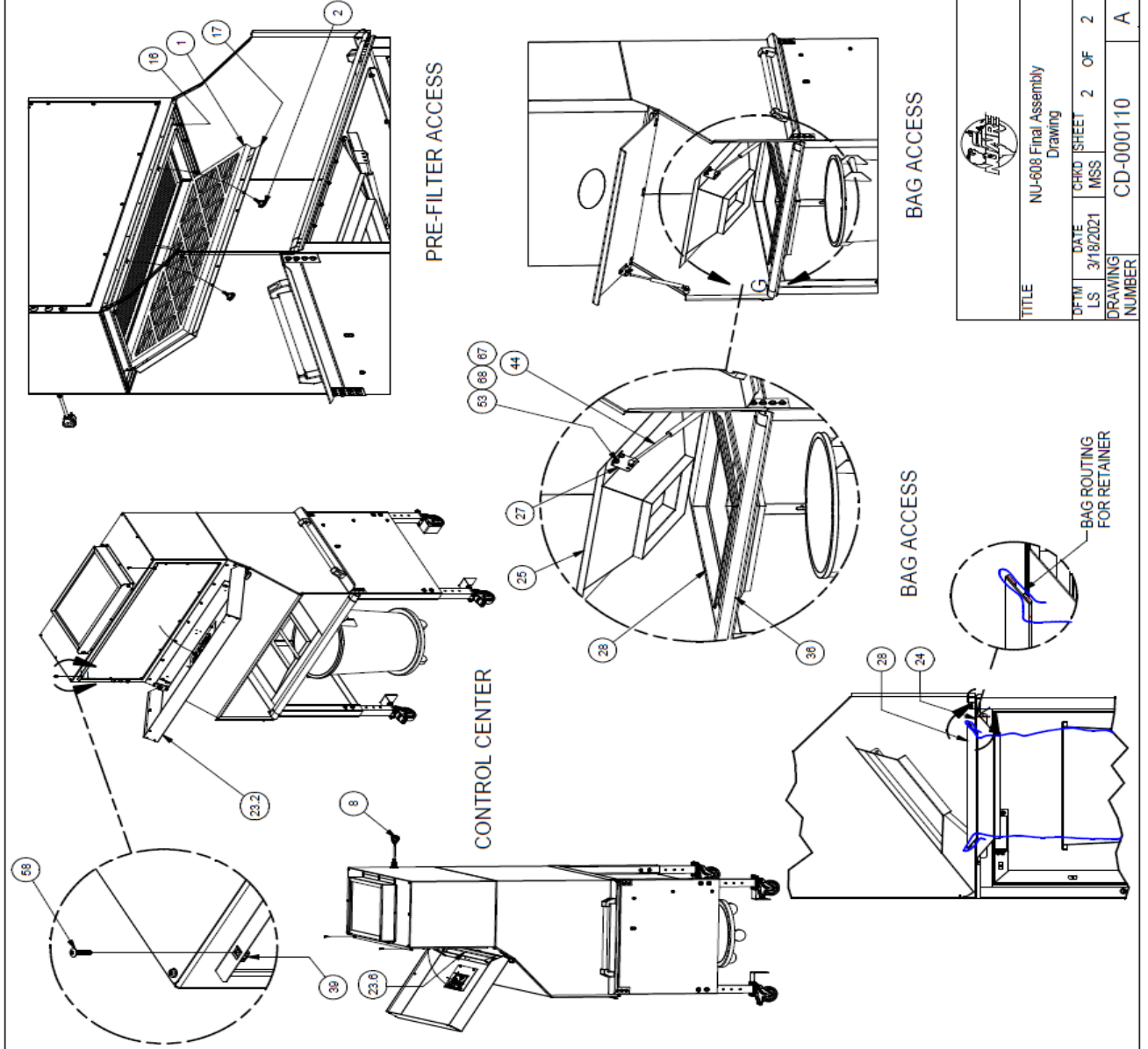

TITLE				NU-608 Final Assembly Drawing			
DFTM	DATE	CHKD	SHEET	2	OF	2	
LS	3/18/2021	MSS					
DRAWING NUMBER				CD-000110		A	

